

# CONNECTOR, PLUG, RIGHT ANGLE – MIL-C-24231

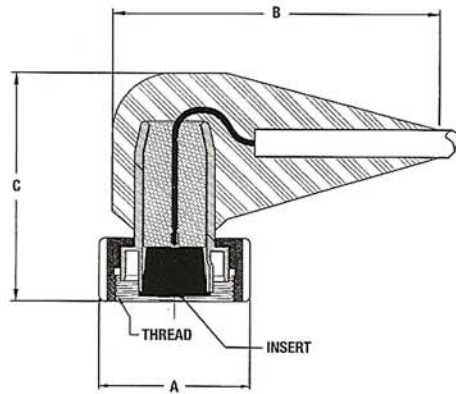

AMETEK SCP PART NUMBER	MILITARY PART NUMBER	SYMBOL NUMBER	"A" DIM	"B" DIM	"C" DIM	THREAD UN-2B	INSERT (SOCKET)
CP1413-3-90	M24231/2-001	713.5	2.00	4.37	3.75	1.688-12	3 EA. #16
CP1413-4-90	M24231/2-002	713.8	2.00	4.37	3.75	1.688-12	4 EA. #16
CP1413-5-90	M24231/2-003	N/A	2.00	4.37	3.75	1.688-12	5 EA. #16
CP1414-7-90	M24231/3-003	N/A	2.50	4.87	3.75	2.000-12	7 EA. #16
CP1414-9-90	M24231/3-004	N/A	2.50	4.87	3.75	2.000-12	9 EA. #16
CP1415-6-90	N/A	N/A	3.37	5.43	5.37	2.750-12	6 EA. #16
CP1415-14-90	M24231/4-006	N/A	3.37	5.43	5.37	2.750-12	14 EA. #16
CP1415-24-90	M24231/4-007	N/A	3.37	5.43	5.37	2.750-12	24 EA. #16
CP1415-30-90	M24231/4-008	N/A	3.37	5.43	5.37	2.750-12	30 EA. #16
CP1415-40-90	M24231/4-009	N/A	3.37	5.43	5.37	2.750-12	40 EA. #16
CP1414-3-90	N/A	N/A	2.50	4.87	3.75	2.000-12	3 EA. #12

## CONFIGURATIONS AVAILABLE

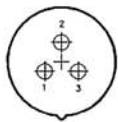

3 EACH #16

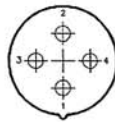

4 EACH #16

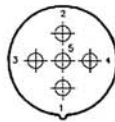

5 EACH #16

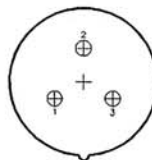

3 EACH #12

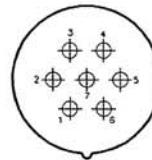

7 EACH #16

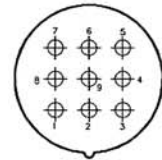

9 EACH #16

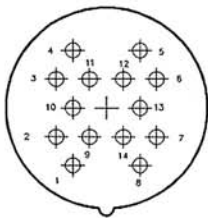

14 EACH #16

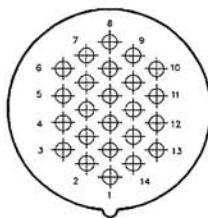

24 EACH #16

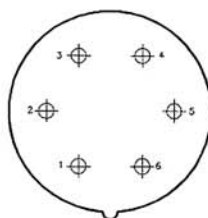

6 EACH #16

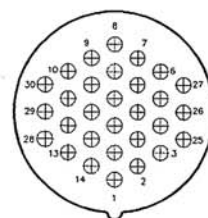

30 EACH #16

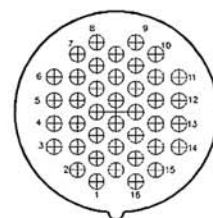

40 EACH #16