



SMB and SMC Connectors

ONLINE CATALOG

Contents

CLICK ON ANY LINE TO GO DIRECTLY TO THE INDICATED PAGE

Navigation Guide	2
Specifications and interface dimensions	3

SMB Cable Connectors

Straight Cable Plugs	4
Right Angle Cable Plugs	4
Bulkhead Mounted Cable Jacks	4

SMB Receptacles

Bulkhead Jack Receptacles.....	5
Panel Jack Receptacles.....	5
P.C. Board Receptacles	6
PressMount Receptacles	6

SMC Cable Connectors

Straight Cable Plugs	7
Right Angle Cable Plugs	7
Bulkhead Mounted Cable Jacks	7

SMC Receptacles

Bulkhead Jack Receptacles.....	8
Panel Jack Receptacles.....	8
P.C. Board Receptacles	8

Technical Information

Mounting Figures	9
Cable Groups.....	10
Cable Assembly Instructions	11
Assembly Tooling	11
Ordering and Warranty.....	12

We have configured this online catalog to take advantage of Acrobat navigation shortcuts (links). However, these links are not visible on the pages— making them visible would compromise the page’s readability.

- Clicking on any entry in the Table of Contents will take you to the indicated page.
- Shown below are the “hot spots” on all of the product pages that will take you to background information on various connector characteristics.
- After you use a link to jump to another page, you can use the “back” arrow in Acrobat’s menu bar to return to the page you jumped from.
- Configure Acrobat Reader to show bookmarks for a table of contents by specific characteristic (for example, cable plugs broken out by cable attachment method).
- To find a specific part number, use Acrobat’s search feature.

In addition, the pages are formatted to fit within the margins of standard laser or inkjet printers—no need to use the “shrink to fit” option when printing pages from Acrobat.

Click [here](#) to go to the Table of Contents

Click on the Delta logo on any page to jump to the table of contents.

Click on the page title to jump to specifications and interface dimensions.

BNC Cable Jacks

Panel Jack—Military Clamp for Flexible Cable

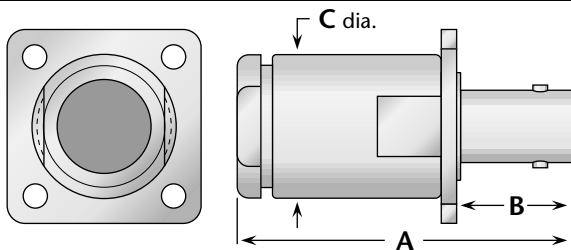

Figure 1

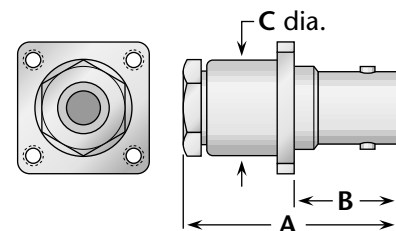

Figure 2

Cable Group	Fig.	Dimensions			Mounting Figure	Plating		Delta P/N	Assembly Procedure/Trim Code
		A	B	C		Body	Contact		
1	1	1.75	.63	.75	33	Nickel	Silver	1011-001-N330	A/20
2, 3	1	1.75	.63	.75	33	Nickel	Silver	1011-004-N330	A/20
5, 6	2	1.16	.55	.50	07	Nickel	Silver	UG-291C/U	A/17

Click here to jump to dimensions for Delta mounting figures.

Click here to jump to the cable assembly procedure for this connector.

Click here to jump to a guide to Delta cable groups.

Click here to go to Delta’s website if your computer is configured for Web connection via Acrobat.

General Description

Delta SMB connectors are subminiature, 50Ω impedance connectors with snap-on coupling. They are best suited for use with cables in the range of .070" to .120" diameter, such as RG-178 and RG-316/U.

Delta SMC connectors (page 7) are similar in size and construction to SMB series, but employ #10–32 threaded coupling, and have a higher upper frequency limit than SMB.

All Delta SMB and SMC connectors are available with gold-plated bodies, or with nickel-plated bodies for economy.

As with our other connector series, Delta's *customer-driven design* results in SMB and SMC series connectors with practical and unique features that make your design and assembly process easier. Some of these include:

- SMB *PressMount* receptacles (page 6) mount securely in a single round hole, saving space on your components and reducing your housing fabrication costs.
- SMB and SMC panel receptacles with flange sizes to match the same hole pattern as standard SMA connectors, letting you drill one hole pattern and mount SMB, SMC, BNC, N, SMA, or TNC series connectors as needed.

Our SMB and SMC series product line is still growing, so call if you don't see what you need.

For adapters between SMB or SMC and other series, download the document *DeltaABS.pdf* from our website.

SMB and SMC Specifications*

SMB Interfaces**

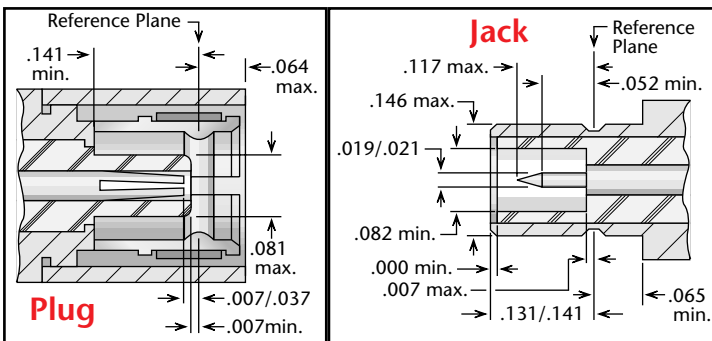

Electrical:

Nominal Impedance: 50 ohms.

Frequency Range: SMB: DC–4 GHz.

SMC: DC–10 GHz.

Voltage Rating: 250 volts RMS (when used with RG-178-class cables); 335 volts RMS (when used with RG-316-class cables).

Dielectric Withstanding

Voltage: 750 volts RMS (when used with RG-178-class cables); 1,000 volts RMS (when used with RG-316-class cables).

Insulation Resistance: 1,000 megohms.

Materials/Finishes:

Insulators: Teflon per ASTM D1710.

Male Contacts: Brass per ASTM B16.

Female Contacts: Beryllium Copper per ASTM B196.

Contact Plating: Gold per MIL-G-45204.

Gaskets: Silicone rubber per ZZ-R-765, Class II, Grade 50.

Other Metal Parts: Brass per ASTM B16, plated: Gold per MIL-G-45208, or Nickel per QQ-N-290.

SMC Interfaces**

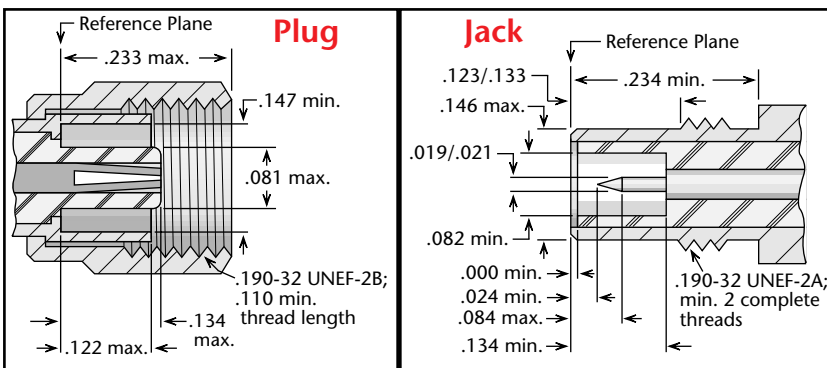

All other specifications are in accordance with the latest issues of MIL-PRF-39012, or MIL-A-55339, or other applicable MIL specifications, and interfaces are in accordance with MIL-STD-348.

*These specifications are typical and may not apply to all connectors. Detailed specifications for individual connectors are available on request.

**Some proportions altered to illustrate detail.

Straight and Right Angle Plugs—For Flexible Cable

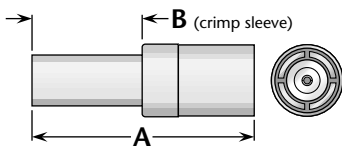

Figure 1
(Crimp type)

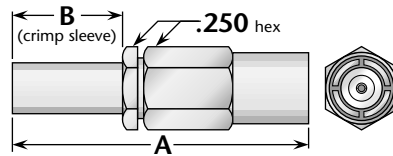

Figure 2
(Crimp type)

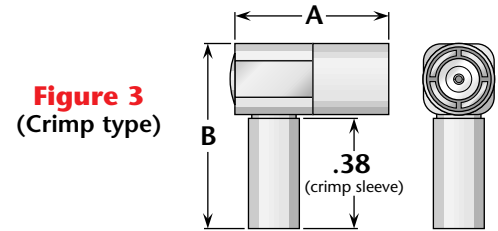

Figure 3
(Crimp type)

Cable Group	Figure	Dimensions		Plating		Delta P/N	Assembly Procedure/ Trim Code
		A	B	Body	Contact		
9	1	.80	.38	Gold	Gold	2403-037-G000-2	B/28
9	1	.80	.38	Nickel	Gold	2403-037-N000-2	B/28
9	2	1.03	.38	Gold	Gold (C)	2402-037-G001	***
9	2	1.03	.38	Nickel	Gold (C)	2402-037-N001	***
9	3	.52	.63	Gold	Gold (C)	2407-037-G001	B/29
9	3	.52	.63	Nickel	Gold (C)	2407-037-N001	B/29
10	1	.80	.38	Gold	Gold	2403-100-G000	B/28
10	1	.80	.38	Nickel	Gold	2403-100-N000	B/28
10	2	1.03	.38	Gold	Gold (C)	2402-100-G001	***
10	2	1.03	.38	Nickel	Gold (C)	2402-100-N001	***
10	3	.52	.63	Gold	Gold (C)	2407-100-G001	B/29
10	3	.52	.63	Nickel	Gold (C)	2407-100-N001	B/29
11	1	.80	.38	Gold	Gold	2403-038-G000-1	***
11	1	.80	.38	Nickel	Gold	2403-038-N000-1	***
11	2	1.03	.38	Gold	Gold (C)	2402-038-G001	***
11	2	1.03	.38	Nickel	Gold (C)	2402-038-N001	***
11	3	.52	.63	Gold	Gold (C)	2407-038-G001-1	B/29
11	3	.52	.63	Nickel	Gold (C)	2407-038-N001-1	B/29

Bulkhead Jack—For Flexible Cable

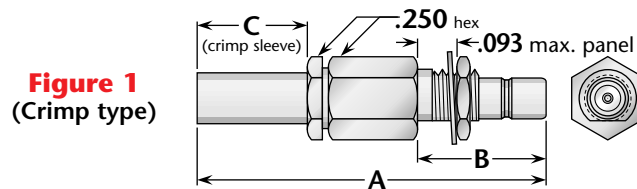

Figure 1
(Crimp type)

Cable Group	Fig.	Dimensions			Mounting Figure	Plating		Delta P/N	Assembly Procedure/ Trim Code
		A	B	C		Body	Contact		
9	1	1.17	.426	.38	68	Gold	Gold (C)	2419-037-G681	***
9	1	1.17	.426	.38	68	Nickel	Gold (C)	2419-037-N681	***
10	1	1.17	.426	.38	68	Gold	Gold (C)	2419-100-G681	***
10	1	1.17	.426	.38	68	Nickel	Gold (C)	2419-100-N681	***
11	1	1.17	.426	.38	68	Gold	Gold (C)	2419-038-G681	***
11	1	1.17	.426	.38	68	Nickel	Gold (C)	2419-038-N681	***

***Contact factory for cable assembly instructions. • (C) in contact plating column indicates captive contact.

Bulkhead Jack Receptacles

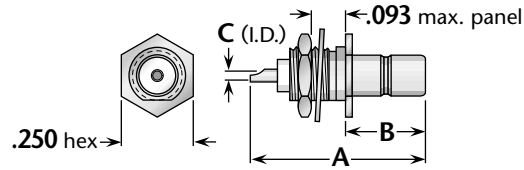

Figure 1

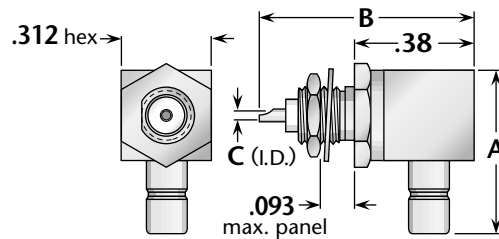

Figure 2

Figure	Dimensions			Mounting Figure	Plating		Delta P/N
	A	B	C		Body	Contact	
1	.59	.265	.035	68	Gold	Gold (C)	2420-000-G681
1	.59	.265	.035	68	Nickel	Gold (C)	2420-000-N681
2	.59	.75	.022	68	Gold	Gold (C)	2422-000-G681
2	.59	.75	.022	68	Nickel	Gold (C)	2422-000-N681

Panel Jack Receptacle

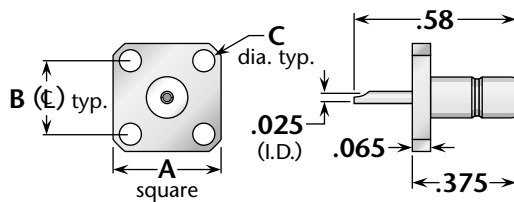

Figure 1
(3/8" square flange)

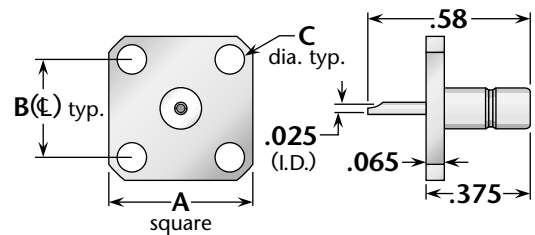

Figure 2
(1/2" square flange)

Figure	Dimensions			Mounting Figure	Plating		Delta P/N
	A	B	C		Body	Contact	
1	.375	.232	.093	91A	Gold	Gold (C)	2413-000-G911
1	.375	.232	.093	91A	Nickel	Gold (C)	2413-000-N911
2	.500	.340	.102	05	Gold	Gold (C)	2413-000-G051
2	.500	.340	.102	05	Nickel	Gold (C)	2413-000-N051

(C) in contact plating column indicates captive contact.

Printed-Circuit Board Receptacles

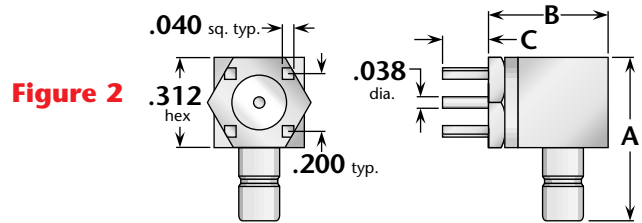
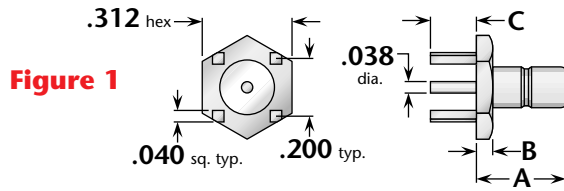
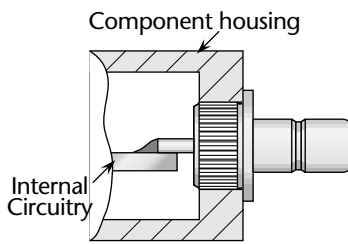

Figure	Dimensions			Max. Board	Mounting Figure	Plating		Delta P/N
	A	B	C			Body	Contact	
1	.300	.060	.155	.100	PCB06	Gold	Gold (C)	2468-000-G001
1	.300	.060	.155	.100	PCB06	Nickel	Gold (C)	2468-000-N001
2	.59	.375	.155	.100	PCB06	Gold	Gold (C)	2470-000-G00E
2	.59	.375	.155	.100	PCB06	Nickel	Gold (C)	2470-000-N00E

PressMount Receptacles

Delta PressMount Receptacles



Front mount

These connectors eliminate the need for complicated mounting hole patterns and mounting hardware. They are simply pressed into a single through hole, and the precisely-engineered knurled mounting section provides retention strength far greater than normal mating and unmating forces. An integral shoulder provides a positive stop when mounting.

PressMounts are available for a wide variety of Delta connector series, and can be used in packages as small as the outer diameter of the connector body.

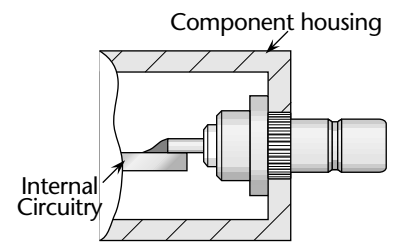

Rear mount

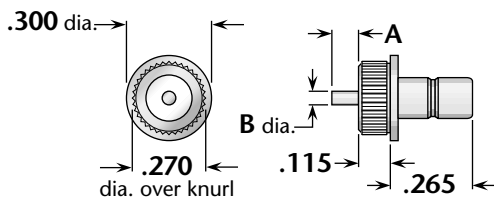

Figure 1
(Post contact, front mount, stainless steel body)

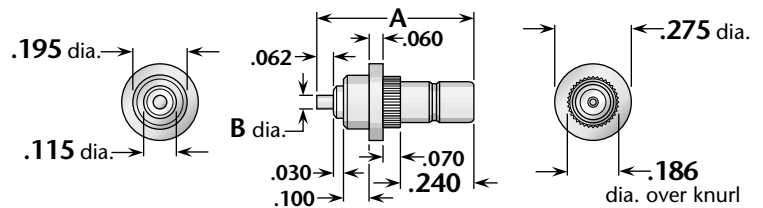

Figure 2
(Post contact, rear mount, brass body)

Figure	Dimensions		Min. Panel	Mounting Hole	Plating		Delta P/N
	A	B			Body	Contact	
1	.062	.050	.100	.267 ±.001 dia.	Passivated	Gold (C)	2420-000-K911-1
2	.500	.060	.062	.182 ±.001 dia.	Gold	Gold (C)	2421-000-G911

(C) in contact plating column indicates captive contact.

Straight and Right Angle Plugs—For Flexible Cable

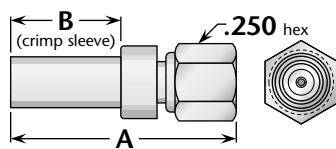

Figure 1
(Crimp type)

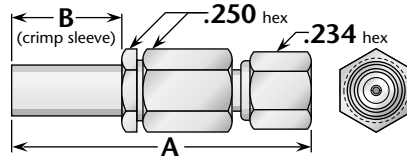

Figure 2
(Crimp type)

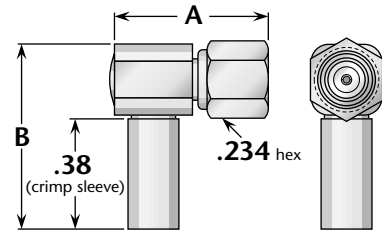

Figure 3
(Crimp type)

Cable Group	Figure	Dimensions		Plating		Delta P/N	Assembly Procedure/ Trim Code
		A	B	Body	Contact		
9	1	.80	.38	Gold	Gold	2503-037-G000	B/28
9	1	.80	.38	Nickel	Gold	2503-037-N000	B/28
9	2	1.03	.38	Gold	Gold (C)	2502-045-G001-1	***
9	2	1.03	.38	Nickel	Gold (C)	2502-045-N001-1	***
9	3	.56	.63	Gold	Gold (C)	2507-037-G001	B/29
9	3	.56	.63	Nickel	Gold (C)	2507-037-N001	B/29
10	1	.80	.38	Gold	Gold	2503-100-G000	B/28
10	1	.80	.38	Nickel	Gold	2503-100-N000	B/28
10	2	1.03	.38	Gold	Gold (C)	2502-100-G000-1	***
10	2	1.03	.38	Nickel	Gold (C)	2502-100-N000-1	***
10	3	.56	.63	Gold	Gold (C)	2507-100-G001	B/29
10	3	.56	.63	Nickel	Gold (C)	2507-100-N001	B/29
11	1	.80	.38	Gold	Gold	2503-038-G000	B/28
11	1	.80	.38	Nickel	Gold	2503-038-N000	B/28
11	2	1.03	.38	Gold	Gold (C)	2502-038-G001-1	***
11	2	1.03	.38	Nickel	Gold (C)	2502-038-N001-1	***
11	3	.56	.63	Gold	Gold (C)	2507-038-G001	B/29
11	3	.56	.63	Nickel	Gold (C)	2507-038-N001	B/29

Bulkhead Jack—For Flexible Cable

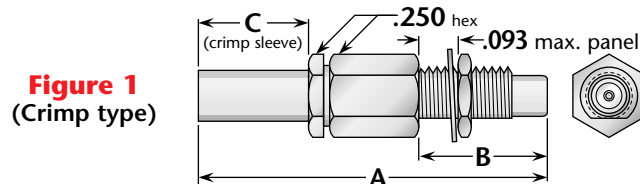

Figure 1
(Crimp type)

Cable Group	Fig.	Dimensions			Mounting Figure	Plating		Delta P/N	Assembly Procedure/ Trim Code
		A	B	C		Body	Contact		
9	1	1.17	.426	.38	68	Gold	Gold (C)	2519-037-G681	***
9	1	1.17	.426	.38	68	Nickel	Gold (C)	2519-037-N681	***
10	1	1.17	.426	.38	68	Gold	Gold (C)	2519-100-G681	***
10	1	1.17	.426	.38	68	Nickel	Gold (C)	2519-100-N681	***
11	1	1.17	.426	.38	68	Gold	Gold (C)	2519-038-G681	***
11	1	1.17	.426	.38	68	Nickel	Gold (C)	2519-038-N681	***

***Contact factory for cable assembly instructions. • (C) in contact plating column indicates captive contact.

Bulkhead Jack Receptacles

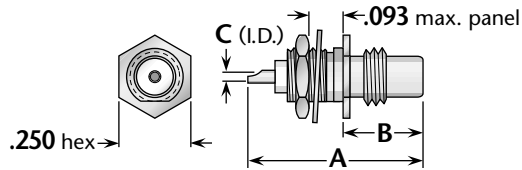

Figure 1

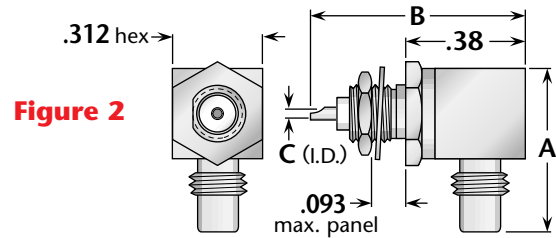

Figure 2

Figure	Dimensions			Mounting Figure	Plating		Delta P/N
	A	B	C		Body	Contact	
1	.59	.265	.035	68	Gold	Gold (C)	2520-000-G681
1	.59	.265	.035	68	Nickel	Gold (C)	2520-000-N681
2	.59	.75	.022	68	Gold	Gold (C)	2522-000-G681
2	.59	.75	.022	68	Nickel	Gold (C)	2522-000-N681

Panel Jack Receptacle

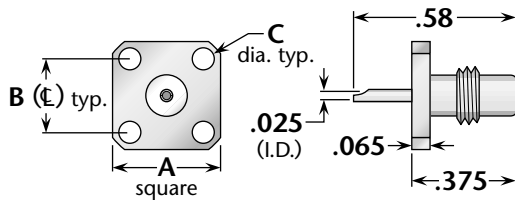

Figure 1
(3/8" square flange)

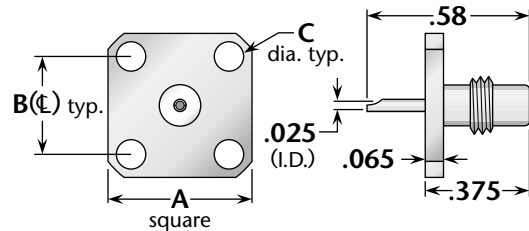

Figure 2
(1/2" square flange)

Figure	Dimensions			Mounting Figure	Plating		Delta P/N
	A	B	C		Body	Contact	
1	.375	.232	.093	91A	Gold	Gold (C)	2513-000-G911
1	.375	.232	.093	91A	Nickel	Gold (C)	2513-000-N911
2	.500	.340	.102	05	Gold	Gold (C)	2513-000-G051
2	.500	.340	.102	05	Nickel	Gold (C)	2513-000-N051

Printed-Circuit Board Receptacles

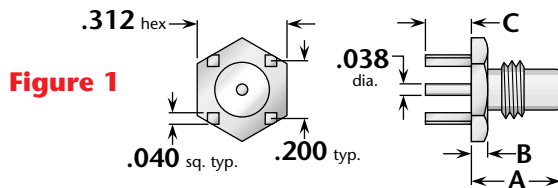

Figure 1

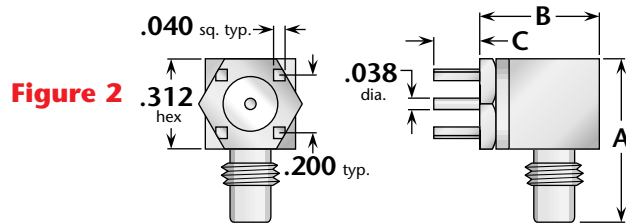
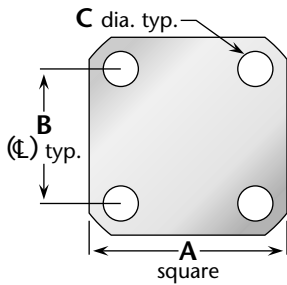

Figure 2

Figure	Dimensions			Max. Board	Mounting Figure	Plating		Delta P/N
	A	B	C			Body	Contact	
1	.300	.060	.155	.100	PCB06	Gold	Gold (C)	2568-000-G001
1	.300	.060	.155	.100	PCB06	Nickel	Gold (C)	2568-000-N001
2	.59	.375	.155	.100	PCB06	Gold	Gold (C)	2570-000-G00E
2	.59	.375	.155	.100	PCB06	Nickel	Gold (C)	2570-000-N00E

(C) in contact plating column indicates captive contact.

Connector Flanges (Panel mounted connectors)



4-hole flanges

Figure	A	B	C
04	1/2	.360	.089
05	1/2	.340	.102
07	11/16	.500	#3-56 tap
08	11/16	.500	.136
09	11/16	.500	.125
10	11/16	.500	.120
12	11/16	.500	.109
18	3/4	.531	.136
26	1	.718	#6-32 tap
27	1	.718	#4-40 tap
30	1	.718	.166
32	1	.718	.136
32A	1	.718	.136*
33	1	.718	.125
34	13/32	.812	.150
36	13/16	.906	#6-32 tap
39	13/16	.906	.152
40	13/16	.906	.125
45	2	1.437	.257
91	.375	.250	.067
91A	.375	.232	.093

* Countersunk to .245 dia.

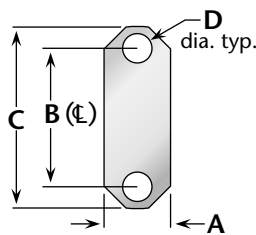

2-hole flanges

Figure	A	B	C	D
92	.223	.481	.625	.102
92A	.260	.481	.625	.102
95	.640	1.015	1.30	.125

Panel Cutouts (Bulkhead mounted connectors)

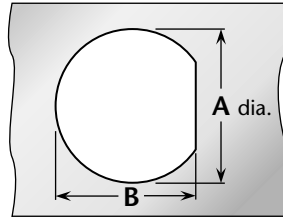

D-Hole

Figure	A	B
51	.755	.723
54	.630	.598
55	.630	.583
57	.557	.531
59	.505	.473
62	.442	.410
63	.407	.362
65	.380	.348
66	.319	.292
67	.255	.236
68	.195	.176

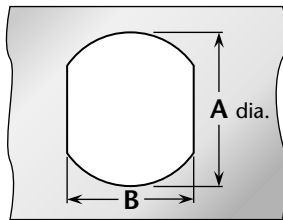

Double D-Hole

Figure	A	B
69	.755	.692
72	.630	.536
75	.380	.341
84	.319	.278

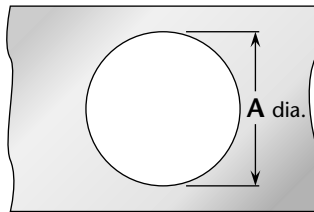

Round Hole

Figure	A
82	.255
89	.380

P.C. Board Drilling

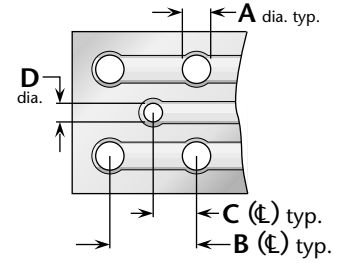

(PCB traces are shown for illustrative purpose only, and are not representative of actual circuitry.)

Coaxial connectors

Figure	A	B	C	D
PCB01	.067	.400	.200	.045
PCB02	.045	.500	.250	.045
PCB03	.067	.300	.150	.035
PCB05	.067	.200	.100	.055
PCB06	.067	.200	.100	.045
PCB07	.045	.177	.088	.045
PCB08	.032	.100	.050	.032

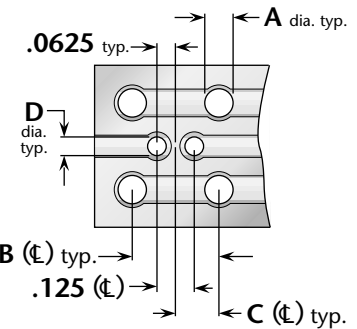

(PCB traces are shown for illustrative purpose only, and are not representative of actual circuitry.)

Twiax connectors

Figure	A	B	C	D
PCB04	.045	.500	.250	.045

Cable Group Finder			
Cable	Group	Cable	Group
RG-5, 5A, B	1A	RG-225	3C
RG-6, 6A	1B	RG-228A	20
RG-8, 8A	2A	RG-302	22
RG-9, 9A, B	3A	RG-303	23
RG-10	15	RG-304	24
RG-11, 11A	2B	RG-316	9A
RG-12	15	RG-316DS	10
RG-13A	3B	RG-393	4
RG-14A	16	RG-400	6A
RG-17A	17	RG-401	12
RG-18A	18	RG-402	13
RG-21, 21A	1A	RG-405	14
RG-22, 22A, B	28	M17/2	1B
RG-55, 55B	6B	M17/6	2B
RG-55A	6A	M17/15	28
RG-58, 58A, C	5	M17/28	5
RG-59, 59A, B	7A	M17/29	7A
RG-62, 62A, B, C	7A	M17/30	7A
RG-71, 71A, B	7B	M17/45	27
RG-108, 108A	27	M17/73	1A
RG-115A	19	M17/162	1A
RG-118A	20	M17/112	1C
RG-122	8A	M17/74	2A
RG-126	21	M17/75	3A
RG-141, 141A	5	M17/127	3C
RG-142, 142A	6A	M17/77	3B
RG-142B	6B	M17/60	6A
RG-143, 143A	1C	M18/84	6A
RG-174	9A	M17/128	6A
RG-174DS	10	M17/97	7A
RG-178, 178A, B	11	M17/54	8A
RG-179A, 179B	9B	M17/95	8B
RG-180, 180A, B	8B	M17/137	8B
RG-187, 187A	9B	M17/152	9A
RG-188, 188A	9A	M17/93	11
RG-195	8B	M17/129	12
RG-196, 196A	11	M17/130	13
RG-210	7A	M17/133	14
RG-212	1C	M17/78	16
RG-213	2A	M17/165	16
RG-214	3A	M17/176	30
RG-215	15	AT&T 735A	31
RG-217	16	Belden 8281	26
RG-218	17	Belden 9207	29
RG-219	18	Dearborn 6207	29
RG-222	1C	IBM 7362211	29
RG-223	6A		

Delta Cable Groups	
Group	Cables
1	1A RG-5, 5A, 5B, 21, 21A; M17/73, /162
	1B RG-6, 6A; M17/2
	1C RG-143, 143A, 212, 222; M17/73, /112, /162
2	2A RG-8, 8A, 213; M17/74
	2B RG-11, 11A; M17/6
3	3A RG-9, 9A, 9B, 214; M17/75
	3B RG-13A, 216; M17/77
	3C RG-225; M17/127
4	RG-393; M17/127
5	RG-58, 58A, 58C, 141, 141A; M17/28, /111
6	6A RG-55A, 142, 142A, 223, 400; M17/60, /84, /128
	6B RG-55, 55B, 142B; M17/60, /84
7	7A RG-59, 59A, 59B, 62, 62A, 62B, 62C, 210; M17/29, /30, /97
	7B RG-71, 71A, 71B; M17/90
8	8A RG-122; M17/54
	8B RG-180, 180A, 180B, 195; M17/95, /137
9	9A RG-174, 188, 188A, 316; M17/152
	9B RG-179A, 179B, 187, 187A; M17/94, /136
10	Double-Shielded RG-174, 316; M17/152
11	RG-178, 178A, 178B, 196, 196A; M17/93
12	.250" semi-rigid; RG-401; M17/129
13	.141" semi-rigid; RG-402; M17/130
14	.085" semi-rigid; RG-405; M17/133
15	RG-10, 12, 215; M17/6, /74
16	RG-14A, 217; M17/78, /165
17	RG-17A, 218
18	RG-18A, 219
19	RG-115A
20	RG-118A, 228A
21	RG-126
22	RG-302
23	RG-303
24	RG-304
25	Special 8X cable; contact factory for details.
26	Belden 8281
27	RG-108, 108A; M17/45
28	RG-22, 22A, 22B; M17/15
29	Belden 9207; Dearborn 6207; IBM 7362211
30	M17/176
31	AT&T 735A

Assembly Procedure B

- 1) Trim cable per chart. Slide crimp sleeve back onto cable.

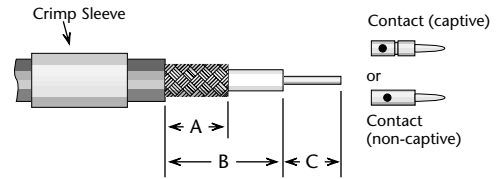

- 2) If support insulator is provided for RG-62 or 71 cable, insert into hollow in dielectric. Solder contact onto center conductor; back of contact flush with trimmed end of cable dielectric (omit this step for right angle connectors with access caps). Flare cut end of braid slightly by rotating dielectric.

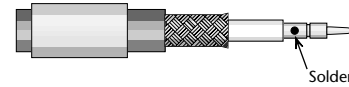

- 3) Insert cable/contact into rear of body, with all braid wires on outside of crimp tail.
- For captive contact connectors, push cable in until contact snaps into insulator.
 - For noncaptive contact connectors, push cable in until cable dielectric bottoms in connector.
 - For right angle or tee connectors with access caps, push cable in until end of braid touches connector body shoulder, and cable center conductor rests in contact slot.

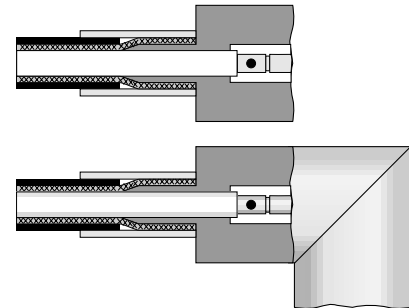

Trim excess braid wires even with shoulder of body. Slide crimp sleeve forward until flush with body and crimp (see page 176 for hex die sizes).

For right angle or tee connectors with access caps, solder center conductor into contact slot, then press cap into body until seated or screw into place.

Trim Codes For Assembly Procedure B

Code	A	B	C
B/28	.219	.271	.078
B/29	.200	.320	.060

Crimp Tools for Flexible Cable

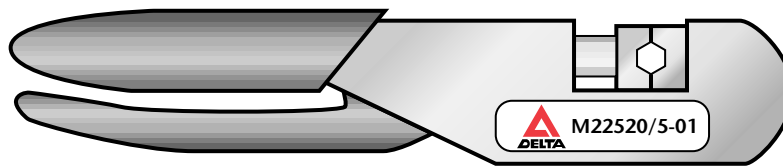

Frame only—P/N M22520/5-01—Use with interchangeable dies listed below.

For Cable Group(s)	Hex Die Size	Die Set P/N	Closure
2, 3, 4	.429 hex, .400 wide	M22520/5-61	A
5, 6	.213 hex, .400 wide	M22520/5-19	B
7	.255 hex, .400 wide	M22520/5-19	A
9	.128 hex, .400 wide	M22520/5-35	B
10	.151 hex, .400 wide	M22520/5-37	B
11	.105 hex, .400 wide	M22520/5-33	B



Warranty

We warrant our parts to be free from defects in materials and workmanship for one year from date of purchase. During that time, we will repair or replace (at our option) any parts found to be defective.

This warranty does not apply to parts which have been modified, used in conditions exceeding Delta or military specifications, or disassembled. We will not, under any circumstances, be responsible for consequential or incidental damages or installation costs.

No other warranties apply, and no other liability may be assumed or extended by representatives or distributors.

Returns

Returns will be accepted only with a Return Authorization number issued by Delta, and are subject to inspection and acceptance upon arrival. Restocking charges will be determined prior to issuance of Return Authorization.

All claims for shortages must be made within 30 days of receipt by customer.

Ordering Information

Orders are subject to the terms and conditions on our order acknowledgement, which may only be modified by written agreement prior to sale. Order changes, cancellation, or termination will be accepted only with written approval from Delta Electronics Manufacturing.

Copyright, Trademarks, and Patents

Entire contents copyright 2003, Delta Electronics Manufacturing Corporation. Reproduction rights are hereby granted for, and specifically limited to, printing or other reproduction of drawings and specifications for inclusion in specification or source control drawings, or for purchasing procedures, by Delta customers only.

Heli-Grip, *PressMount*, and the New England Craftsmanship logo are trademarks. The Heli-Grip design is covered by U.S. and foreign patents.

Delta Electronics Manufacturing Corporation
416 Cabot Street, P.O. Box 53
Beverly, MA 01915
FSCM/CAGE 00795

Catalog # SMBCpdf2008 1.1