



MCX Connectors

ONLINE CATALOG

Contents

CLICK ON ANY LINE TO GO DIRECTLY TO THE INDICATED PAGE

Navigation Guide	2
Specifications and interface dimensions	3

Cable Connectors

Straight Cable Plugs.	4
Right Angle Cable Plugs.	4
Straight Cable Jacks.	5
Bulkhead Cable Jacks	5

Receptacles

Straight PCB Jack Receptacles.	6
Right Angle PCB Jack Receptacles	6
PCB Plug Receptacles.	7
PressMount Jack Receptacles	7

Technical Information

Assembly Instructions	8
Mounting Figures.	9
Ordering Information and Warranty	10

We have configured this online catalog to take advantage of Acrobat navigation shortcuts (links). However, these links are not visible on the pages—making them visible would compromise the page’s readability.

- Clicking on any entry in the Table of Contents will take you to the indicated page.
- Shown below are the “hot spots” on all of the product pages that will take you to background information on various connector characteristics.
- After you use a link to jump to another page, you can use the “back” arrow in Acrobat’s menu bar to return to the page you jumped from.
- Configure Acrobat Reader to show bookmarks for a table of contents by specific characteristic (for example, cable plugs broken out by cable attachment method).
- To find a specific part number, use Acrobat’s search feature.

In addition, the pages are formatted to fit within the margins of standard laser or inkjet printers—no need to use the “shrink to fit” option when printing pages from Acrobat.

Click [here](#) to go to the Table of Contents

Click on the Delta logo on any page to jump to the table of contents.

Click on the page title to jump to specifications and interface dimensions.

BNC Cable Jacks

Panel Jack—Military Clamp for Flexible Cable

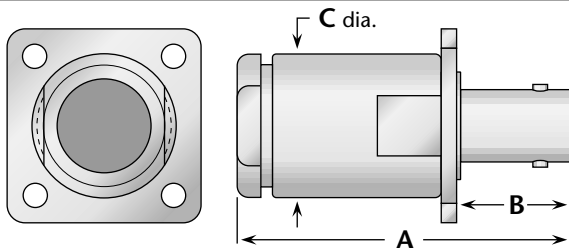

Figure 1

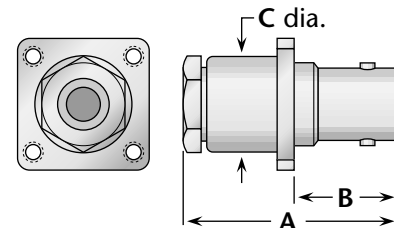

Figure 2

Cable Group	Fig.	Dimensions			Mounting Figure	Plating		Delta P/N	Assembly Procedure/Trim Code
		A	B	C		Body	Contact		
1	1	1.75	.63	.75	33	Nickel	Silver	1011-001-N330	A/20
2, 3	1	1.75	.63	.75	33	Nickel	Silver	1011-004-N330	A/20
5, 6	2	1.16	.55	.50	07	Nickel	Silver	UG-291C/U	A/17

Click here to jump to dimensions for Delta mounting figures.

Click here to jump to the cable assembly procedure for this connector.

Click here to go to Delta’s website if your computer is configured for Web connection via Acrobat.

General Description

Delta MCX connectors are subminiature, 50Ω impedance connectors with snap-on coupling. They are best suited for use with cables in the range of .070" to .120" diameter, such as RG-178 and RG-316/U.

These connectors provide small size, light weight, and economy with the convenience of snap-on mating and the ability to rotate connector pairs after mating for precise alignment

All Delta MCX connectors are available with gold-plated bodies, or with nickel-plated bodies for economy.

As with our other connector series, Delta's customer-driven design results in MCX series connectors with practical and unique features that make your design and assembly process easier. Some of these include:

- PressMount receptacles mount securely in a single round hole, saving space on your components and reducing your housing fabrication costs.
- P. C. board receptacles with a choice of through-hole, edge mounting, or surface mounting.
- P. C. board jack receptacle that fit flush with the edge of boards, ideal for daughterboard applications.

Our MCX series product line is still growing, so please call if you don't see what you need.

MCX Specifications*

Plug Interface**

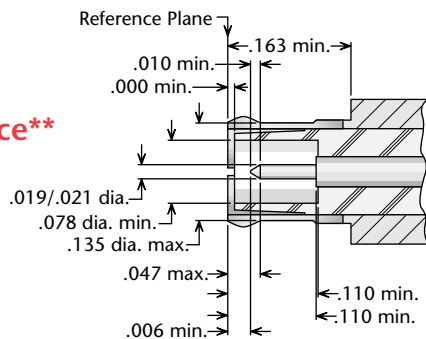

Jack Interface**

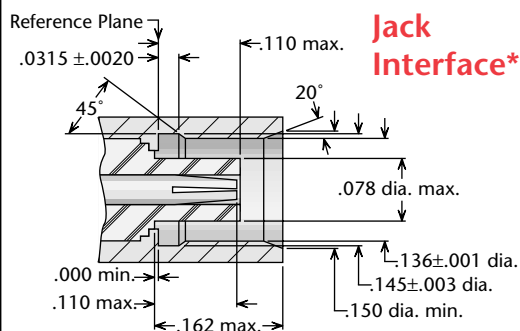

**Some proportions altered to illustrate detail.

Electrical:

Nominal Impedance: 50 ohms.

Frequency Range: DC–6 GHz.

Voltage Rating: 250–335 volts RMS (dependent on cable).

Dielectric Withstanding

Voltage: 750–1000 volts RMS (dependent on cable).

Insulation Resistance: 1,000 megohms.

Materials/Finishes:

Insulators: Teflon per ASTM D1710.

Male Contacts: Brass per ASTM B16, or

Beryllium Copper per ASTM B196.

Female Contacts: Beryllium Copper per ASTM B196.

Contact Plating: Gold per MIL-G-45204.

Gaskets: Silicone rubber per ZZ-R-765,

Class II, Grade 50.

Other Metal Parts: Brass per ASTM B16 or equivalent, plated

Gold per MIL-G-45204, or Nickel per QQ-N-290.

All other specifications are in accordance with the latest issues of CECC 22220, series MCX.

*These specifications are typical and may not apply to all connectors. Detailed specifications for individual connectors are available on request.

Straight Cable Plugs

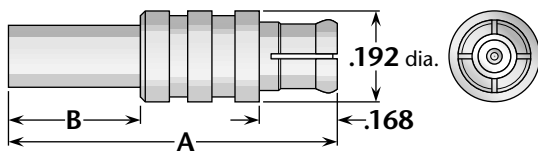

Figure 1
(Crimp type for flexible cable)

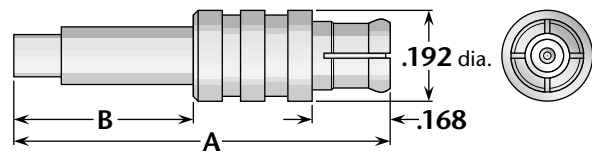
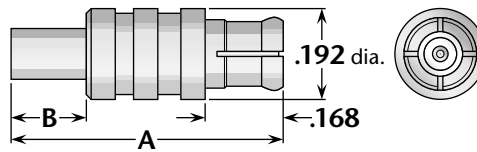

Figure 2
(Crimp type for flexible cable)

Figure 3
(Direct solder for semi-rigid cable)



Cable Group	Figure	Dimensions		Plating		Delta P/N	Assembly Procedure/ Trim Code
		A	B	Body	Contact		
9	1	.69	.27	Gold*	Gold	9803-037-G000-500	B/32
10	1	.69	.27	Gold*	Gold	9803-100-G000-500	B/32
11	2	.79	.37	Gold*	Gold	9803-038-G000-500	B/33
14	3	.58	.16	Gold*	Gold	9801-025-G003-500	H/03

Right Angle Cable Plugs

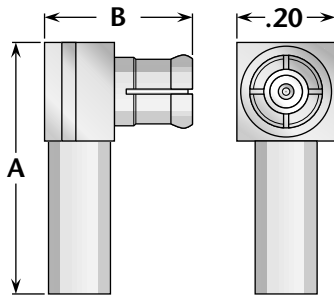

Figure 1
(Crimp type for flexible cable)

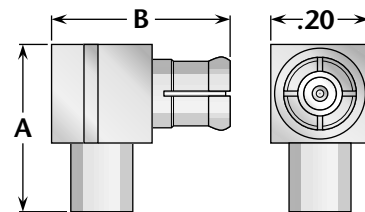

Figure 2
(Direct solder for semi-rigid cable)

Cable Group	Figure	Dimensions		Plating		Delta P/N	Assembly Procedure/ Trim Code
		A	B	Body	Contact		
9	1	.52	.31	Gold*	Gold (C)	9807-037-G001-500	L/04
10	1	.52	.31	Gold*	Gold (C)	9807-100-G001-500	L/04
11	1	.47	.31	Gold*	Gold (C)	9807-038-G001-500	L/04
13	2	.38	.37	Gold*	Gold (C)	9805-031-G003-500	J/03
14	2	.38	.37	Gold*	Gold (C)	9805-025-G003-500	J/03

Cable Groups

9	RG-174, 179, 187, 188, 316; M17/94, 136, 152	13	.141" semi-rigid; RG-402; M17/130
10	Double-Shielded RG-174, 316; M17/152	14	.085" semi-rigid; RG-405; M17/133
11	RG-178, 178A, 178B, 196, 196A; M17/93		

* Also available with nickel-plated body—change G in Delta part number to N.
(C) in contact plating column indicates captive contact.

Straight Cable Jacks

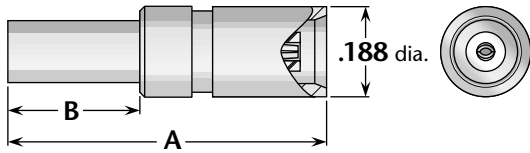

Figure 1
(Crimp type for flexible cable)

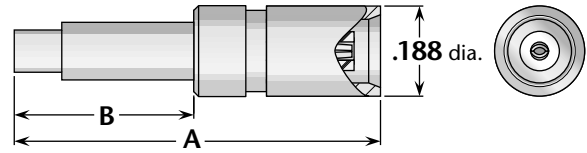

Figure 2
(Crimp type for flexible cable)

Cable Group	Figure	Dimensions		Plating		Delta P/N	Assembly Procedure/ Trim Code
		A	B	Body	Contact		
9	1	.66	.27	Gold*	Gold (C)	9810-037-G001-500	B/34
10	1	.66	.27	Gold*	Gold (C)	9810-100-G001-500	B/34
11	2	.78	.37	Gold*	Gold (C)	9810-038-G001-500	B/35

Straight Bulkhead Jack—For Flexible Cable

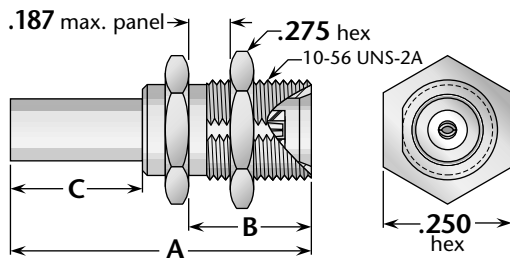

Figure 1
(Crimp type for flexible cable)

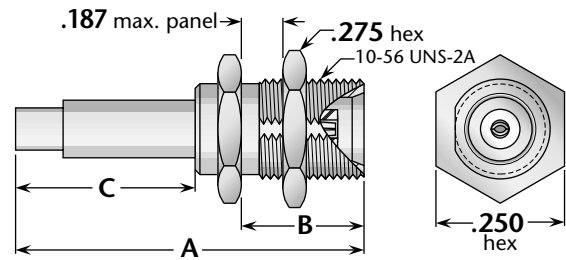

Figure 2
(Crimp type for flexible cable)

Cable Group	Fig.	Dimensions			Mounting Figure	Plating		Delta P/N	Assembly Procedure/ Trim Code
		A	B	C		Body	Contact		
9	1	.69	.307	.27	68	Gold*	Gold (C)	9819-037-G681-500	B/36
10	1	.69	.307	.27	68	Gold*	Gold (C)	9819-100-G681-500	B/36
11	2	.79	.307	.37	68	Gold*	Gold (C)	9819-038-G681-500	***

Cable Groups

9	RG-174, 179, 187, 188, 316; M17/94, 136, 152	13	.141" semi-rigid; RG-402; M17/130
10	Double-Shielded RG-174, 316; M17/152	14	.085" semi-rigid; RG-405; M17/133
11	RG-178, 178A, 178B, 196, 196A; M17/93		

* Also available with nickel-plated body—change G in Delta part number to N.
(C) in contact plating column indicates captive contact.

***Contact factory for assembly procedures.

Straight Printed-Circuit Board Jack Receptacles

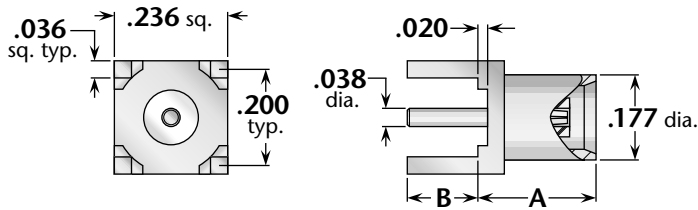

Figure 1
(Through-hole mount)

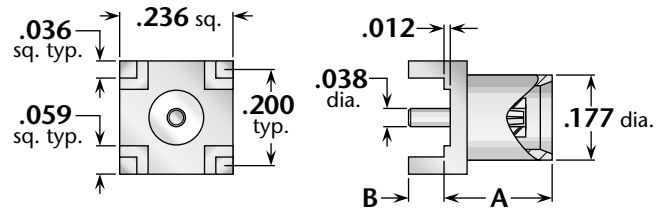

Figure 2
(Through-hole mount)

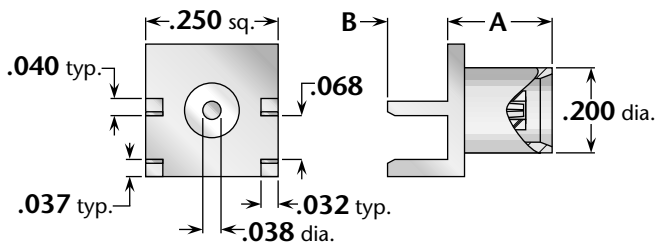

Figure 3
(Edge mount, for .062" thick board)

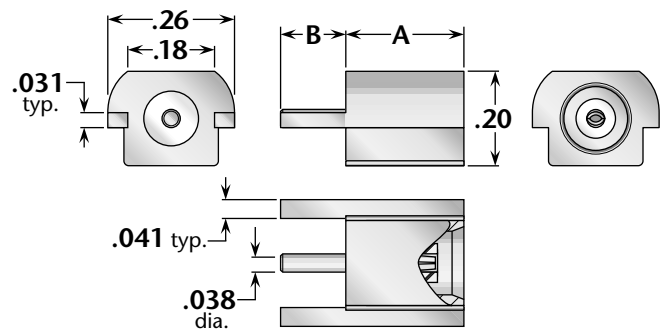

Figure 4
(Flush edge mount)

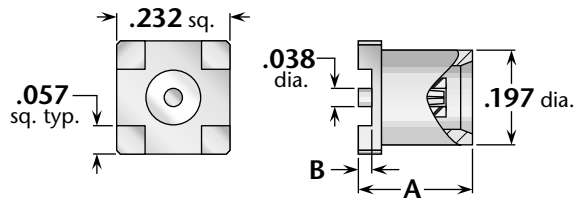

Figure 5
(Surface mount)

Figure	Dimensions		Max. Board	Mounting Figure	Plating		Delta P/N
	A	B			Body	Contact	
1	.218	.155	.100	PCB06	Gold*	Gold (C)	9867-000-G001-500
2	.240	.059	.040	PCB06	Gold*	Gold (C)	9867-000-G001-501
3	.250	.125	N/A	***	Gold*	Gold (C)	9867-000-G91P-500
4	.246	.120	N/A	***	Gold*	Gold (C)	9867-000-G001-503
5	.236	.016	N/A	***	Gold*	Gold (C)	9867-000-G001-504

* Also available with nickel-plated body—change G in Delta part number to N.
(C) in contact plating column indicates captive contact. • ***Contact factory for mounting information.

Right Angle Printed-Circuit Board Jack Receptacle

Figure 1
(Through-hole mount)

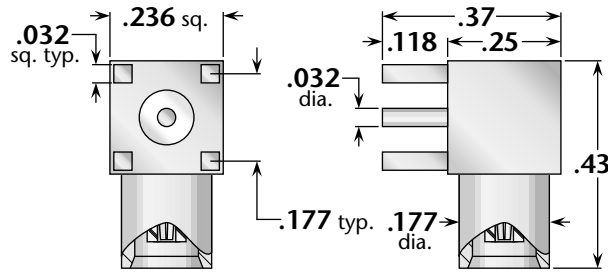

Figure	Max. Board Thickness	Mounting Figure	Plating		Delta P/N
			Body	Contact	
1	.062	PCB07	Gold*	Gold (C)	9869-000-G001-500

Printed-Circuit Board Plug Receptacles

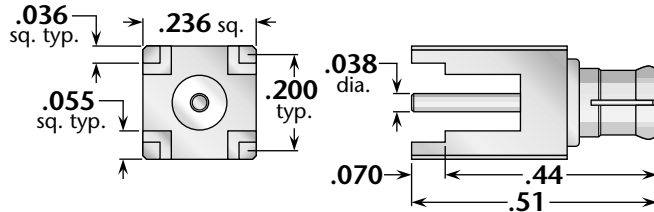

Figure 1
(Straight—through-hole mounting)

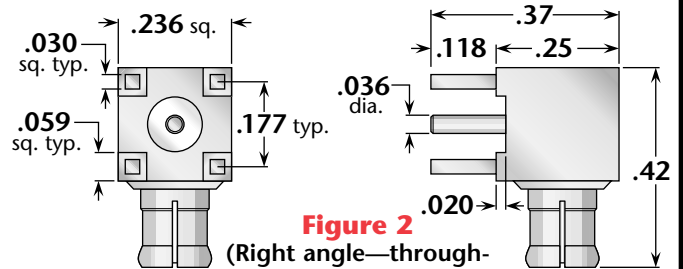
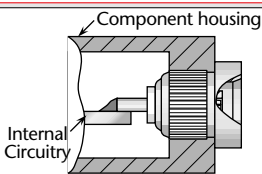

Figure 2
(Right angle—through-hole mounting)

Figure	Max. Board Thickness	Mounting Figure	Plating		Delta P/N
			Body	Contact	
1	.050	PCB06	Gold*	Gold (C)	9868-000-G001-500
2	.062	PCB07	Gold*	Gold (C)	9870-000-G001-500

PressMount Receptacles



Delta PressMount Receptacles

These connectors eliminate the need for complicated mounting hole patterns and mounting hardware. They are simply pressed into a single through hole, and the precisely-engineered knurled mounting section provides retention strength far greater than normal mating and unmating forces. An integral shoulder provides a positive stop when mounting.

Figure 1 (Post contact)

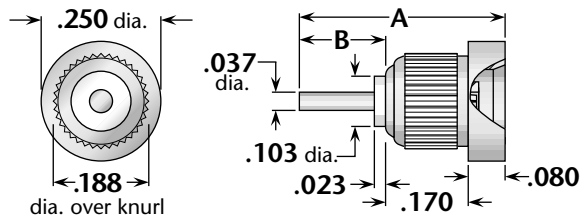

Figure	Dimensions		Min. Panel	Mounting Hole	Plating		Delta P/N
	A	B			Body	Contact	
1	.40	.15	.100	.184 ±.001 dia.	Gold*	Gold (C)	9820-000-G911-1
1	.73	.48	.100	.184 ±.001 dia.	Gold*	Gold (C)	9820-000-G911-8

* Also available with nickel-plated body—change G in Delta part number to N.
(C) in contact plating column indicates captive contact.



Assembly Procedure B

- 1) Trim cable per chart. Slide crimp sleeve back onto cable.

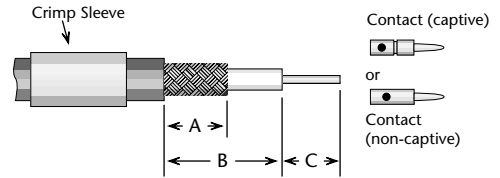

- 2) If support insulator is provided for RG-62 or 71 cable, insert into hollow in dielectric. Solder contact onto center conductor; back of contact flush with trimmed end of cable dielectric (omit this step for right angle connectors with access caps). Flare cut end of braid slightly by rotating dielectric.



- 3) Insert cable/contact into rear of body, with all braid wires on outside of crimp tail.
 - a) For captive contact connectors, push cable in until contact snaps into insulator.
 - b) For noncaptive contact connectors, push cable in until cable dielectric bottoms in connector.
 - c) For right angle or tee connectors with access caps, push cable in until end of braid touches connector body shoulder, and cable center conductor rests in contact slot.

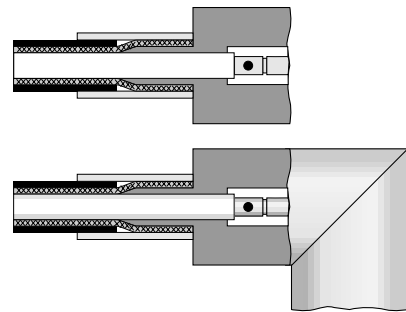

Trim excess braid wires even with shoulder of body. Slide crimp sleeve forward until flush with body and crimp (see page 176 for hex die sizes).

For right angle or tee connectors with access caps: Solder center conductor into contact slot, assemble insulator disc (if supplied), then press cap into body until seated or screw into place.

Trim Codes For Assembly Procedure B

Code	A	B	C
B/32	.175	.260	.095
B/33	.195	.270	.045
B/34	.150	.250	.105
B/36	.150	.325	.090

Assembly Procedure H

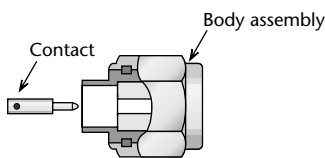

Trim Codes	
Code	A
H/01	.090
H/02	.060
H/03	.115
H/04	.150

- 1) Trim cable as shown. Remove any burrs from jacket and center conductor.

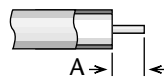

- 2) Solder contact to center conductor, fixturing to maintain gap as shown. Remove any excess solder from outside of contact.

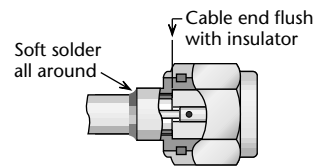
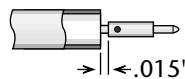

- 3) Insert cable into body and solder cable jacket to body, keeping end of cable flush with insulator as shown.

Plug body assembly and contact shown; procedure is identical for jack connectors.

Assembly Procedure J

Trim Codes		
Code	A	B
J/01	.109	.047
J/02	.059	.039
J/03	.059	.079
J/04	.050	.059

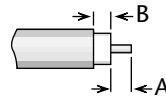

1) Trim cable as shown. Remove any burrs from jacket and center conductor.

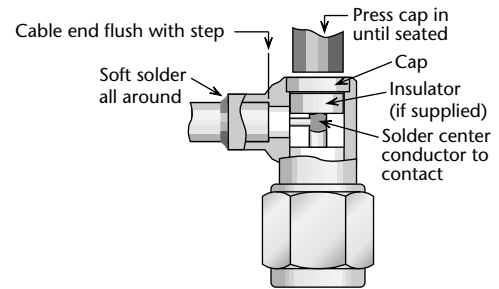

2) Soft solder cable jacket to body, making sure that end of cable is flush with step in body. Solder center conductor into contact slot, assemble insulator disc (if supplied), then press cap into body until seated or screw into place.

Assembly Procedure L

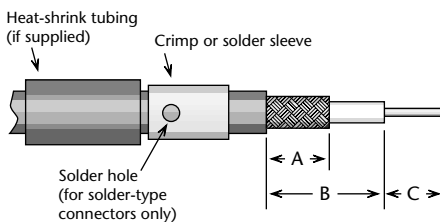

1) Trim cable per chart. Slide crimp (or solder) sleeve and heat-shrink tubing (if supplied) back onto cable.

Trim Codes			
Code	A	B	C
L/01	.250	.438	.109
L/02	.125	.219	.109
L/03	.234	.344	.109
L/04	.195	.270	.050
L/05	.095	.155	.050

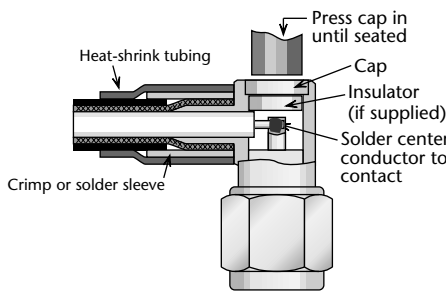

2) Insert cable into rear of body, with all braid wires on outside of crimp tail. Push cable in until end of braid touches connector body shoulder and center conductor rests in contact slot. Trim excess braid wires even with shoulder of body.

Slide crimp sleeve forward until flush with body and crimp (see page 176 for hex die sizes). (For solder-type connectors, solder braid to body and sleeve through hole in sleeve.)

Slide heat-shrink tubing into place and shrink with hot-air gun. Solder center conductor into contact slot, assemble insulator disc (if supplied), then press cap into body until seated or screw into place.

Panel Cutouts (Bulkhead mounted connectors)

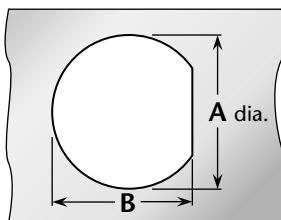

D-Hole

Figure	A	B
68	.195	.176

P.C. Board Drilling

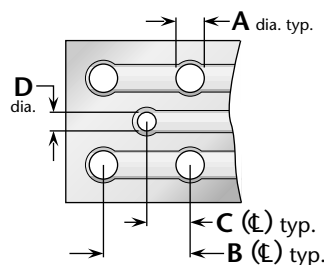

Coaxial connectors

Figure	A	B	C	D
PCB06	.067	.200	.100	.045



Warranty

We warrant our parts to be free from defects in materials and workmanship for one year from date of purchase. During that time, we will repair or replace (at our option) any parts found to be defective.

This warranty does not apply to parts which have been modified, used in conditions exceeding Delta or military specifications, or disassembled. We will not, under any circumstances, be responsible for consequential or incidental damages or installation costs.

No other warranties apply, and no other liability may be assumed or extended by representatives or distributors.

Returns

Returns will be accepted only with a Return Authorization number issued by Delta, and are subject to inspection and acceptance upon arrival. Restocking charges will be determined prior to issuance of Return Authorization.

All claims for shortages must be made within 30 days of receipt by customer.

Ordering Information

Orders are subject to the terms and conditions on our order acknowledgement, which may only be modified by written agreement prior to sale. Order changes, cancellation, or termination will be accepted only with written approval from Delta Electronics Manufacturing.

Copyright, Trademarks, and Patents

Entire contents copyright 2003, Delta Electronics Manufacturing Corporation. Reproduction rights are hereby granted for, and specifically limited to, printing or other reproduction of drawings and specifications for inclusion in specification or source control drawings, or for purchasing procedures, by Delta customers only.

Heli-Grip, *PressMount*, and the New England Craftsmanship logo are trademarks. The Heli-Grip design is covered by U.S. and foreign patents.

Delta Electronics Manufacturing Corporation
416 Cabot Street, P.O. Box 53
Beverly, MA 01915
FSCM/CAGE 00795

Catalog # MCXpdf2008 1.1