

MIL-DTL-38999 Features and Application Series I



Features and Application

MIL-DTL-38999 Series I is a bayonet coupling subminiature configuration with high contact density, ideal for smaller wire gauge, general-purpose applications. These environment-resisting connectors are 100% “scoop-proof.” Pins are recessed in elongated shells to prevent the possibility of bending contacts when plugs are scooped into the mating receptacles.

This family of connectors is offered in 5 receptacle-mounting styles. They include square flange receptacles, for both front and rear panel (wall) mounting; square flange receptacles, for both front and rear box mounting; and jam nut receptacles which incorporate “O” ring seals, designed for rear panel “D” hole mounting.

Standard plugs provide RFI protection by incorporating a continuous strip of attached grounding fingers attenuating interference up to 1 GHz.

Fifty-seven insert arrangements per MIL-STD-1560 are tooled and qualified to MIL-DTL-38999 Series I, utilizing 2 to 128 contacts. Contacts come in sizes 22M, 22D, 20, 16, 12, and 8 (coax and twinax), terminating wire sizes from 28 gauge to 12 gauge including coaxial cable.

These connectors are available in wide range of shell materials and finishes. Aluminum shells are offered in electroless nickel, olive drab cadmium and bright cadmium. Other finishes such as anodic and zinc cobalt are available upon request to commercial callouts only. In addition, we offer passivated stainless steel shells with standard environment-resisting inserts (commercial callouts only), and for highly corrosive environments, nickel-aluminum-bronze shells with standard environment-resisting inserts (commercial callouts only).

Universal I/R Tool – A single, expendable plastic tool is used for both insertion and removal of contacts.

Scoop-Proof Design – Recessed pins in elongated shells minimize the possibility for contact damage. In a blind mating application, mating shells cannot “scoop” the pins, and cause a shorting or bending of contacts.

Closed-Entry Socket Insert – Hard dielectric socket face has lead-in chamfers for positive alignment of pins (even partially bent within pre-established limits) with sockets.

Interfacial Pin Insert Seal – Raised moisture barriers around each pin, which mate into lead-in chamfers of hard face socket insert, provide individual contact sealing. Interfacial seal is never touched by service tools.

Elastomer Wire Sealing Grommet – Sealing over a wide range of wire diameters is assured by a triple wire seal in each cavity at the rear of the connector.

Superior Contact Stability – Rear release crimp contact system features a stamped beryllium-copper retaining clip captivated by molded-in shoulders of each contact cavity in the insulator. A rear-inserted M81969 plastic tool expands the tines beyond the shoulder, releasing the contact.

Shell Polarization – Alternate key/keyway positions prevent cross mating of adjacent connectors having identical insert arrangement.





MIL-DTL-38999

Performance Specifications

Series I

Performance Specifications

Operating Temperature Range

Finish B: -65°C to +175°C (-85°F to +347°F)

Finish F: -65°C to +200°C (-85°F to +392°F)

Finish A: -65°C to +150°C (-85°F to +302°F)

Material and Plating Data (Finish)

B – aluminum shell, olive drab cadmium over nickel base

F – aluminum shell, electroless nickel finish

A – aluminum shell, silver to light iridescent yellow color (bright) cadmium over electroless nickel

Corrosion Resistance

Finishes A and B withstand 500-hour salt spray.

Finish F withstands 48-hour salt spray.

Durability

Minimum of 500 mating cycles

Environmental Seal

Wired, mated connectors with specified accessories attached, shall meet the altitude-immersion test specified in MIL-DTL-38999.

Fluid Resistance

Connectors resist specified immersions in MIL-PRF-7808, MIL-PRF-23699, MIL-PRF-5606, M2-V Chevron oil, Coolanol 25, MIL-DTL-83133 (JP-8), MIL-DTL-5624 (JP-4, JP-5), SAE-AMS1424 Type I, and other solvents and cleaning agents.

Shell-to-Shell Conductivity

- Finish F = 1.0 millivolt maximum potential drop
- Finishes A and B = 2.5 millivolts maximum potential drop

Voltage Rating

Service Rating	Suggested Operating Voltage		Test Voltage	Test Voltage	Test Voltage	Test Voltage
	(Sea Level)		Sea Level	50,000 Ft.	70,000 Ft.	100,000 Ft.
	AC (RMS)	DC	V RMS	V RMS	V RMS	V RMS
M	400	550	1300	550	350	200
N	300	450	1000	400	260	200
I	600	850	1800	600	400	200
II	900	1250	2300	800	500	200

Note: The establishment of electrical safety factors is left entirely to the designer, as he is in the best position to know

Shielding Effectiveness

RFI and EMI attenuation at the specified frequencies meet the requirements of MIL-DTL-38999.

- RFI shielding effectiveness of mated connectors with RFI backshells is measured in a triaxial radio frequency leakage fixture.
- EMI shielding effectiveness is measured at the interface of mated connectors and tested by the mode-stirred technique specified in method 3008 of MIL-STD-1344.

Shock and Vibration Requirements

Wired, mated connectors shall not be damaged, nor shall there be a current interruption longer than one microsecond when subjected to the following:

Standard Shock

Mated connectors withstand a pulse of approximate half sine wave of 300 G \pm 15 percent magnitude with duration of 3 \pm 1 milliseconds applied in three axes per MIL-STD-1344, method 2004.

High Impact Shock

When mounted as specified in MIL-S-901, grade A, a drop of a 400 lb. Hammer from 1 foot, 3 feet and 5 feet applied to connector in three axes, totaling nine impacts.

Vibration

Mated connectors, with proper accessories, withstand the following vibration levels:

- Sine Vibration per MIL-STD-202, method 204, test condition G.
- Random Vibration per MIL-STD-1344, method 205, test condition V and test condition VI, Letter "J" at ambient temperature.

exactly what peak voltages, switching currents, transients, etc., can be expected in a particular circuit.

MIL-DTL-38999

Part Number Development

Series I



Military and Aero-Electric Part Number Development

Mil. Prefix	MS	27467	T	13	B	35	P	A	
Aero Prefix	AE	167	T	13	B	35	P	A	-340
Shell Type									
27466 = Front, wall mount receptacle = 166 (Aero p/n)									
27467 = RFI grounding plug = 167 (Aero p/n)									
27468 = Jam nut receptacle = 168 (Aero p/n)									
27496 = Front, box mount receptacle = 196 (Aero p/n)									
27505 = Rear, box mount receptacle = 105 (Aero p/n)									
27656 = Rear, wall mount receptacle = 156 (Aero p/n)									
Class									
T = With acc. thread (MS27466, MS27467, MS27468 & MS27656)									
E = Same as T in line above but is not approved for new design (E-nut is not included)									
= No acc. thread, box mount (MS27496 & MS27505)									
Shell Size									
9, 11, 13, 15, 17, 19, 21, 23 or 25									
Finish (Material & Plating)									
A = Aluminum shell, silver to light iridescent yellow color (bright) cadmium over nickel base									
B = Aluminum shell, olive drab cadmium over electroless nickel base									
F = Aluminum shell, electroless nickel finish									
S = Stainless steel shell, passivated (Aero p/n only)									
Insert Arrangement									
See page 15 thru 19									
Contact Style									
P = Pin									
S = Socket									
A = Pin connector less pins (with intent to use non-standard pin contacts)									
B = Socket connector less sockets (with intent to use non-standard socket contacts)									
Polarization (Keying)									
N = Normal (Omitted in part number)									
A, B, C, or D (B & C keyways are not available in shell size 9)									
Modification (applies to Aero part numbers only)									
01 = Less contacts (is not marked on the part)									
340 = Connector kitted with M85049/27-XXX E-nut									
341 = Connector kitted with M85049/49-2-XXX straight clamp									
342 = Connector kitted with M85049/47XXX right angle clamp									
Consult factory for other modifications									

Note 1: Each connector is furnished with contacts unless ordered less contacts (L/C) as follows: One spare contact for inserts requiring 1 through 26 of each contact and two spares for inserts with more than 26 contacts and a minimum of one sealing plug up to 10% of the number of contacts. Spare Coax and Twinax contacts are not supplied. One insertion/removal tool for each contact size is also included.

Note 2: Proper part number marking has no "0" in front of single digit shell size (9) and no "0" in front of single digit layout. Example of each: J MS27466T9B35S and J MS27466T11B5S. In both, "N" for normal is omitted. In addition, J or JAN must now be marked in front of the MS part number.



MS27466
Front, Wall Mounting Receptacle
AE166

Bayonet Coupling, Crimp Removable, Rear Release, Scoop-Proof

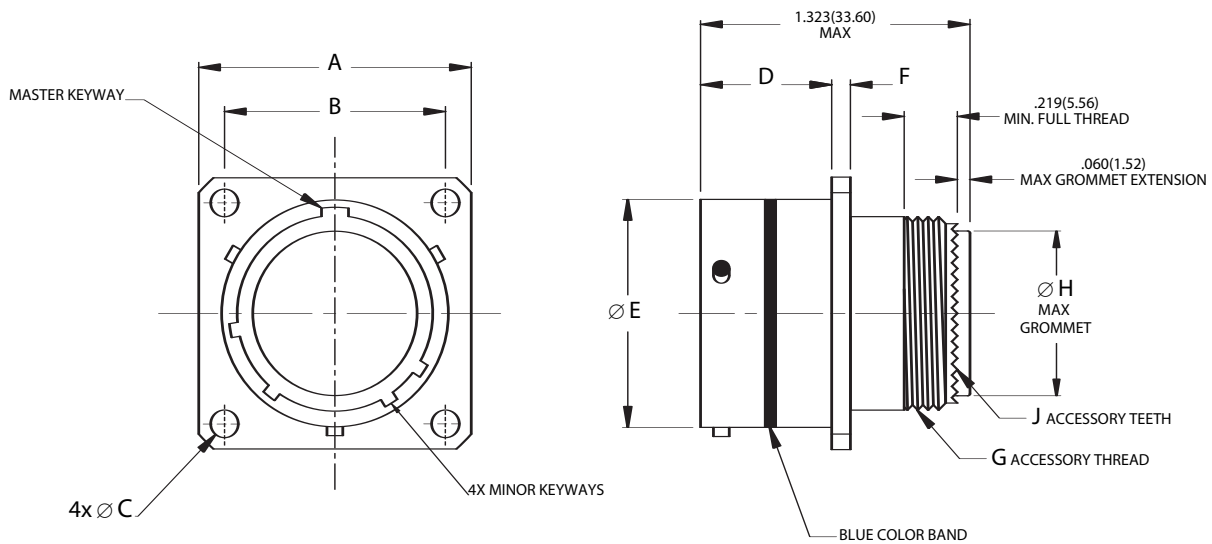

- Page 4 Completed Part Number
- Page 13 Contacts, Sealing Plugs and Tools
- Pages 17-19 Insert Arrangements
- Page 3 Performance Specifications
- Pages 15, 16 Insert Availability and Contact Information
- Page 11 Polarization

Shell Size	A		B		Ø C		D		Ø E		F		G	Ø H		J
	±.020	±.51	(TP)		+0.10	+.25	+0.00	+.00	+0.01	+.03	+0.015	+.38	Accessory Thread	Maximum		No. of Teeth
	inch	mm	inch	mm	inch	mm	inch	mm	inch	mm	inch	mm	UNEF-2A	inch	mm	
9	.938	23.83	.719	18.26	.128	3.25	.632	16.05	.572	14.53	.085	2.16	7/16-28	.299	7.59	12
11	1.031	26.19	.812	20.62	.128	3.25	.632	16.05	.700	17.78	.085	2.16	9/16-24	.427	10.85	16
13	1.125	28.58	.906	23.01	.128	3.25	.632	16.05	.850	21.59	.085	2.16	11/16-24	.541	13.74	20
15	1.219	30.96	.969	24.61	.128	3.25	.632	16.05	.975	24.77	.085	2.16	13/16-20	.666	16.92	24
17	1.312	33.32	1.062	26.97	.128	3.25	.632	16.05	1.100	27.94	.085	2.16	15/16-20	.791	20.09	28
19	1.438	36.53	1.156	29.36	.128	3.25	.632	16.05	1.207	30.66	.085	2.16	1-1/16-18	.897	22.78	32
21	1.562	39.67	1.250	31.75	.128	3.25	.602	15.29	1.332	33.83	.115	2.92	1-3/16-18	1.022	25.96	36
23	1.688	42.88	1.375	34.93	.147	3.73	.602	15.29	1.457	37.01	.115	2.92	1-5/16-18	1.147	29.13	40
25	1.812	46.02	1.500	38.10	.147	3.73	.602	15.29	1.582	40.18	.115	2.92	1-7/16-18	1.272	32.31	44

MS27656

Rear, Wall Mounting Receptacle

AE156



Bayonet Coupling, Crimp Removable, Rear Release, Scoop-Proof

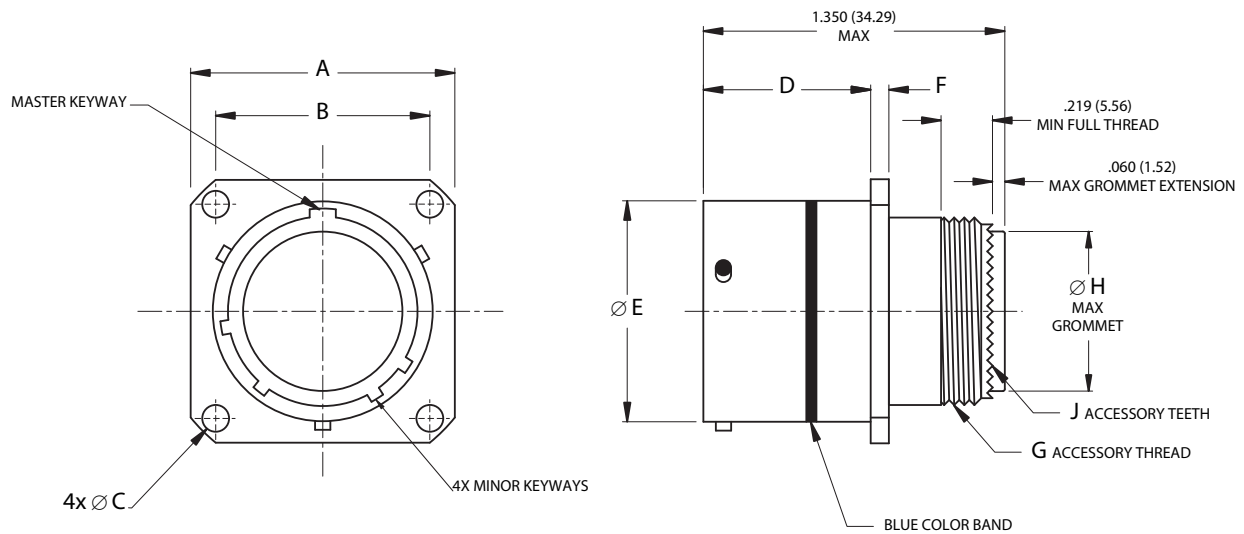

Page 4	Completed Part Number
Page 13	Contacts, Sealing Plugs and Tools
Pages 17-19	Insert Arrangements
Page 3	Performance Specifications
Pages 15, 16	Insert Availability and Contact Information
Page 11	Polarization

Note: See page 12 for panel thickness.

Shell Size	A		B		Ø C		D		Ø E		F		G	Ø H		J
	±.020	±.51	(TP)		+0.10	+.25	+0.00	+.00	+0.01	+.03	+0.015	+.38	Accessory Thread	Maximum		No. of Teeth
	inch	mm	inch	mm	inch	mm	inch	mm	inch	mm	inch	mm	UNEF-2A	inch	mm	
9	.938	23.83	.719	18.26	.128	3.25	.820	20.83	.572	14.53	.085	2.16	7/16-28	.299	7.59	12
11	1.031	26.19	.812	20.62	.128	3.25	.820	20.83	.700	17.78	.085	2.16	9/16-24	.427	10.85	16
13	1.125	28.58	.906	23.01	.128	3.25	.820	20.83	.850	21.59	.085	2.16	11/16-24	.541	13.74	20
15	1.219	30.96	.969	24.61	.128	3.25	.820	20.83	.975	24.77	.085	2.16	13/16-20	.666	16.92	24
17	1.312	33.32	1.062	26.97	.128	3.25	.820	20.83	1.100	27.94	.085	2.16	15/16-20	.791	20.09	28
19	1.438	36.53	1.156	29.36	.128	3.25	.820	20.83	1.207	30.66	.085	2.16	1-1/16-18	.897	22.78	32
21	1.562	39.67	1.250	31.75	.128	3.25	.790	20.07	1.332	33.83	.115	2.92	1-3/16-18	1.022	25.96	36
23	1.688	42.88	1.375	34.93	.147	3.73	.790	20.07	1.457	37.01	.115	2.92	1-5/16-18	1.147	29.13	40
25	1.812	46.02	1.500	38.10	.147	3.73	.790	20.07	1.582	40.18	.115	2.92	1-7/16-18	1.272	32.31	44



MS27496
Front, Box Mounting Receptacle
AE196

Bayonet Coupling, Crimp Removable, Rear Release, Scoop-Proof

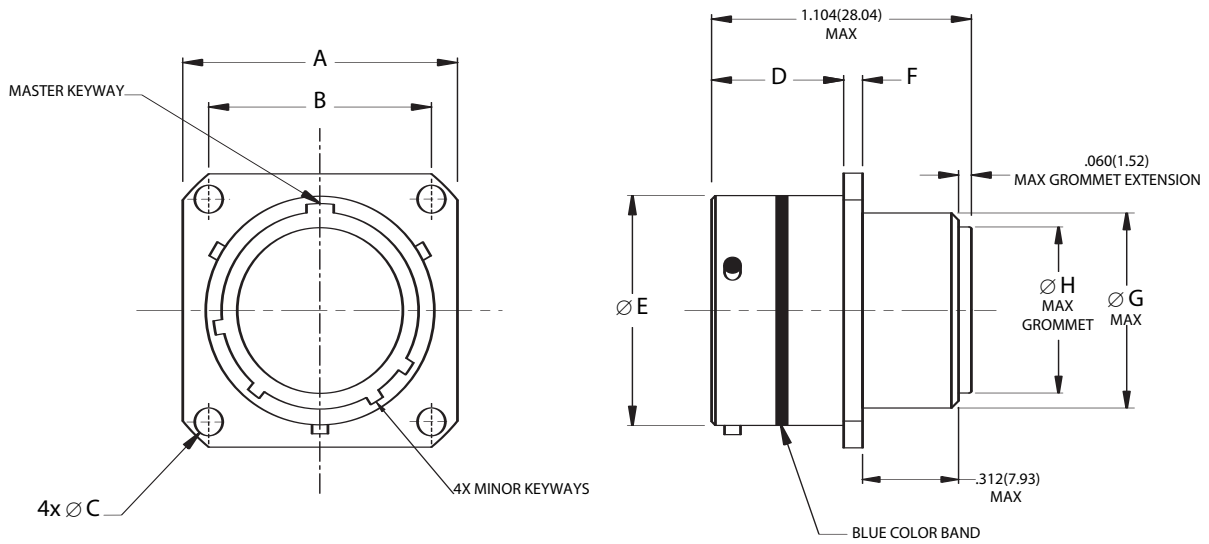

- Page 4 Completed Part Number
- Page 13 Contacts, Sealing Plugs and Tools
- Pages 17–19 Insert Arrangements
- Page 3 Performance Specifications
- Pages 15, 16 Insert Availability and Contact Information
- Page 11 Polarization

Shell Size	A		B		Ø C		D		Ø E		F		Ø G		Ø H	
	±.020	±.51	(TP)		+0.10	+0.25	+0.00	+0.00	+0.001	+0.03	+0.015	+0.38	Maximum		Maximum	
	inch	mm	inch	mm	inch	mm	inch	mm	inch	mm	inch	mm	inch	mm	inch	mm
9	.938	23.83	.719	18.26	.128	3.25	.632	16.05	.572	14.53	.085	2.16	.469	11.91	.299	7.59
11	1.031	26.19	.812	20.62	.128	3.25	.632	16.05	.700	17.78	.085	2.16	.594	15.09	.427	10.85
13	1.125	28.58	.906	23.01	.128	3.25	.632	16.05	.850	21.59	.085	2.16	.719	18.26	.541	13.74
15	1.219	30.96	.969	24.61	.128	3.25	.632	16.05	.975	24.77	.085	2.16	.844	21.44	.666	16.92
17	1.312	33.32	1.062	26.97	.128	3.25	.632	16.05	1.100	27.94	.085	2.16	.969	24.61	.791	20.09
19	1.438	36.53	1.156	29.36	.128	3.25	.632	16.05	1.207	30.66	.085	2.16	1.078	27.38	.897	22.78
21	1.562	39.67	1.250	31.75	.128	3.25	.602	15.29	1.332	33.83	.115	2.92	1.203	30.56	1.022	25.96
23	1.688	42.88	1.375	34.93	.147	3.73	.602	15.29	1.457	37.01	.115	2.92	1.328	33.73	1.147	29.13
25	1.812	46.02	1.500	38.10	.147	3.73	.602	15.29	1.582	40.18	.115	2.92	1.453	36.91	1.272	32.31

MS27505

Rear, Box Mounting Receptacle

AE105



Bayonet Coupling, Crimp Removable, Rear Release, Scoop-Proof

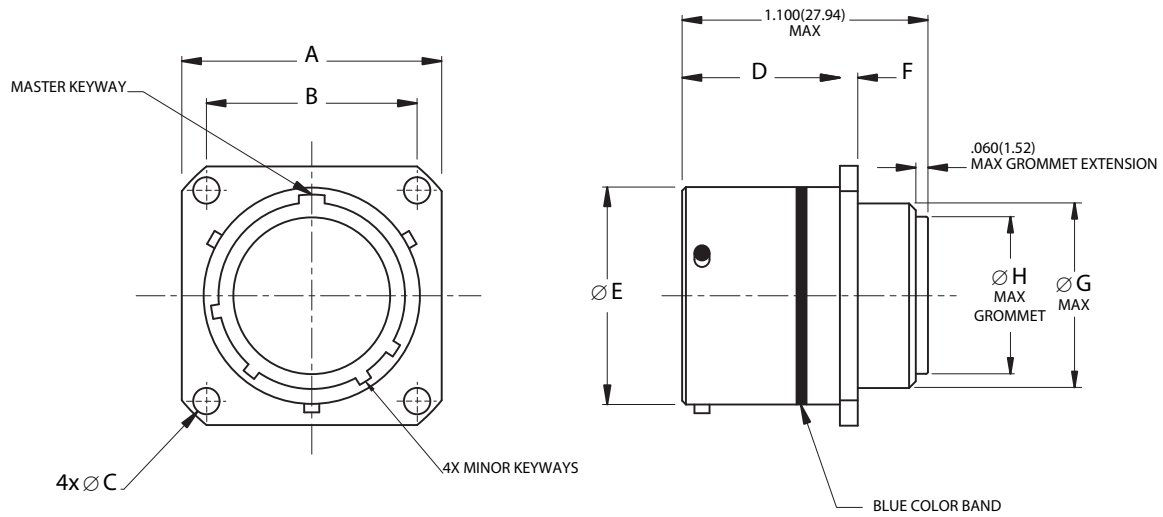

Page 4	Completed Part Number
Page 13	Contacts, Sealing Plugs and Tools
Pages 17–19	Insert Arrangements
Page 3	Performance Specifications
Pages 15, 16	Insert Availability and Contact Information
Page 11	Polarization

Note: See page 12 for panel thickness.

Shell Size	A		B		Ø C		D		Ø E		F		Ø G		Ø H	
	±.020	±.51	(TP)		+0.10	+0.25	+0.00	+0.00	+0.001	+0.03	+0.015	+0.38	Maximum		Maximum	
	inch	mm	inch	mm	inch	mm	inch	mm	inch	mm	inch	mm	inch	mm	inch	mm
9	.938	23.83	.719	18.26	.128	3.25	.820	20.83	.572	14.53	.085	2.16	.547	13.89	.299	7.59
11	1.031	26.19	.812	20.62	.128	3.25	.820	20.83	.700	17.78	.085	2.16	.656	16.66	.427	10.85
13	1.125	28.58	.906	23.01	.128	3.25	.820	20.83	.850	21.59	.085	2.16	.828	21.03	.541	13.74
15	1.219	30.96	.969	24.61	.128	3.25	.820	20.83	.975	24.77	.085	2.16	.953	24.21	.666	16.92
17	1.312	33.32	1.062	26.97	.128	3.25	.820	20.83	1.100	27.94	.085	2.16	1.078	27.38	.791	20.09
19	1.438	36.53	1.156	29.36	.128	3.25	.820	20.83	1.207	30.66	.085	2.16	1.203	30.56	.897	22.78
21	1.562	39.67	1.250	31.75	.128	3.25	.790	20.07	1.332	33.83	.115	2.92	1.328	33.73	1.022	25.96
23	1.688	42.88	1.375	34.93	.147	3.73	.790	20.07	1.457	37.01	.115	2.92	1.453	36.91	1.147	29.13
25	1.812	46.02	1.500	38.10	.147	3.73	.790	20.07	1.582	40.18	.115	2.92	1.578	40.08	1.272	32.31



MS27468
Jam Nut Receptacle
AE168

Bayonet Coupling, Crimp Removable, Rear Release, Scoop-Proof

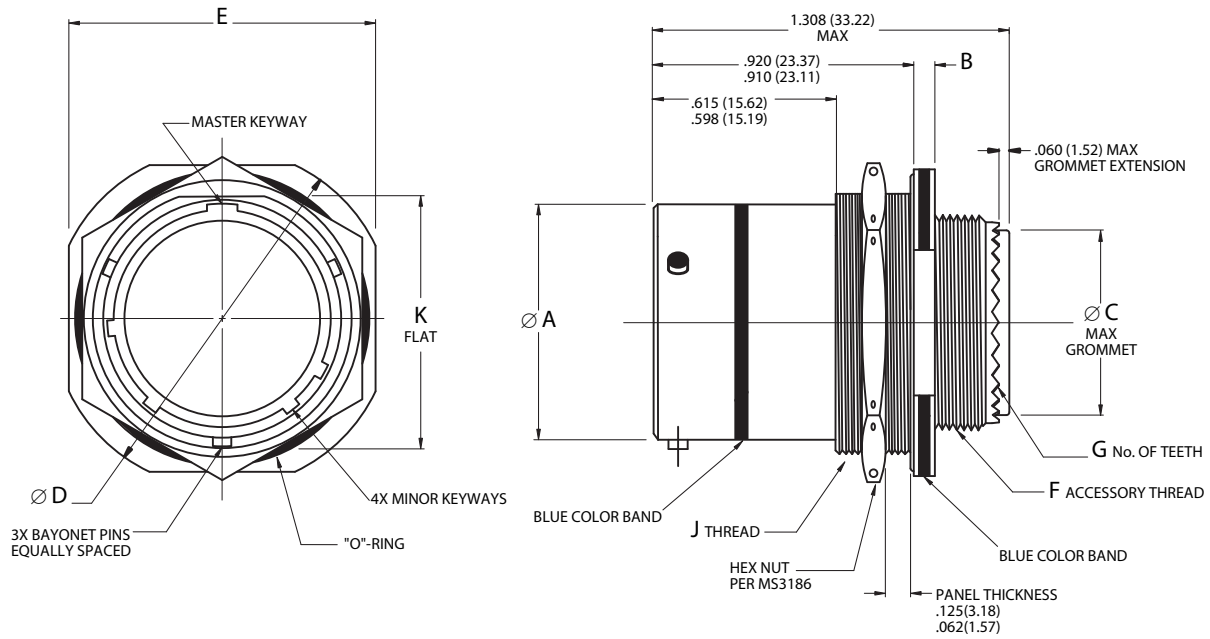

- Page 4 Completed Part Number
- Page 13 Contacts, Sealing Plugs and Tools
- Pages 17–19 Insert Arrangements
- Page 3 Performance Specifications
- Pages 15, 16 Insert Availability and Contact Information
- Page 11 Polarization

Shell Size	Ø A		B		Ø C		Ø D		E		F	G	J	K	
	+0.01	+0.03	+0.011	+0.28	Maximum	±0.016	±0.41	±0.016	±0.41	Accessory Thread	No. of Teeth	Jam Nut Thread Class 2A	Flat		
	-0.005	-0.13	-0.010	-0.25		inch	mm	inch	mm				inch	mm	±.005
	inch	mm	inch	mm	inch	mm	inch	mm	inch	mm	UNE-F- 2A			inch	mm
9	.572	14.53	.109	2.77	.299	7.59	1.188	30.18	1.062	26.97	7/16-28	12	11/16-24UNE-F	.650	16.51
11	.700	17.78	.109	2.77	.427	10.85	1.375	34.93	1.250	31.75	9/16-24	16	13/16-20UNE-F	.750	19.05
13	.850	21.59	.109	2.77	.541	13.74	1.500	38.10	1.375	34.93	11/16-24	20	1-20UNE-F	.937	23.80
15	.975	24.77	.109	2.77	.666	16.92	1.625	41.28	1.500	38.10	13/16-20	24	1-1/8-18UNE-F	1.061	26.95
17	1.100	27.94	.109	2.77	.791	20.09	1.750	44.45	1.625	41.28	15/16-20	28	1-1/4-18UNE-F	1.186	30.12
19	1.207	30.66	.140	3.56	.897	22.78	1.938	49.23	1.812	46.02	1-1/16-18	32	1-3/8-18UNE-F	1.311	33.30
21	1.332	33.83	.140	3.56	1.022	25.96	2.062	52.37	1.938	49.23	1-3/16-18	36	1-1/2-18UNE-F	1.436	36.47
23	1.457	37.01	.140	3.56	1.147	29.13	2.188	55.58	2.062	52.37	1-5/16-18	40	1-5/8-18UNE-F	1.561	39.65
25	1.582	40.18	.140	3.56	1.272	32.31	2.312	58.72	2.188	55.58	1-7/16-18	44	1-3/4-18UNS	1.686	42.82

MS27467
RFI Grounding Plug
AE167



Bayonet Coupling, Crimp Removable, Rear Release, Scoop-Proof

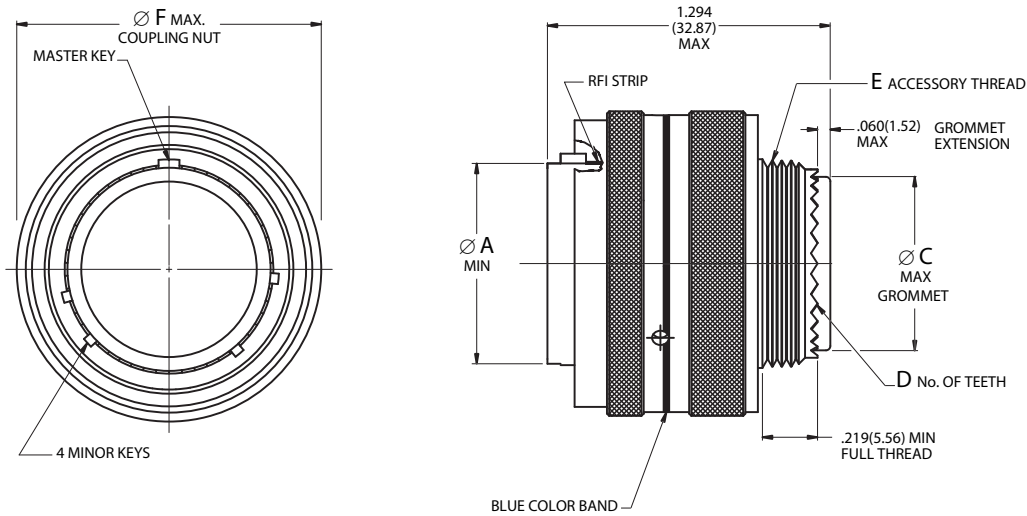

Page 4	Completed Part Number
Page 13	Contacts, Sealing Plugs and Tools
Pages 17–19	Insert Arrangements
Page 3	Performance Specifications
Pages 15, 16	Insert Availability and Contact Information
Page 11	Polarization

Shell Size	Ø A		Ø C		D	E	Ø F	
	Minimum		Maximum		No. of Teeth	Accessory Thread Class 2A	Maximum	
	inch	mm	inch	mm			inch	mm
9	.417	10.59	.299	7.59	12	7/16-28UNEF	.859	21.82
11	.545	13.84	.427	10.85	16	9/16-24UNEF	.984	24.99
13	.657	16.69	.541	13.74	20	11/16-24UNEF	1.156	29.36
15	.782	19.86	.666	16.92	24	13/16-20UNEF	1.281	32.54
17	.907	23.04	.791	20.09	28	15/16-20UNEF	1.406	35.71
19	1.012	25.70	.897	22.78	32	1-1/16-18UNEF	1.516	38.51
21	1.137	28.88	1.022	25.96	36	1-3/16-18UNEF	1.641	41.68
23	1.262	32.05	1.147	29.13	40	1-5/16-18UNEF	1.766	44.86
25	1.387	35.23	1.272	32.31	44	1-7/16-18UNEF	1.891	48.03



MIL-DTL-38999 Polarization Series I

Keying Positions

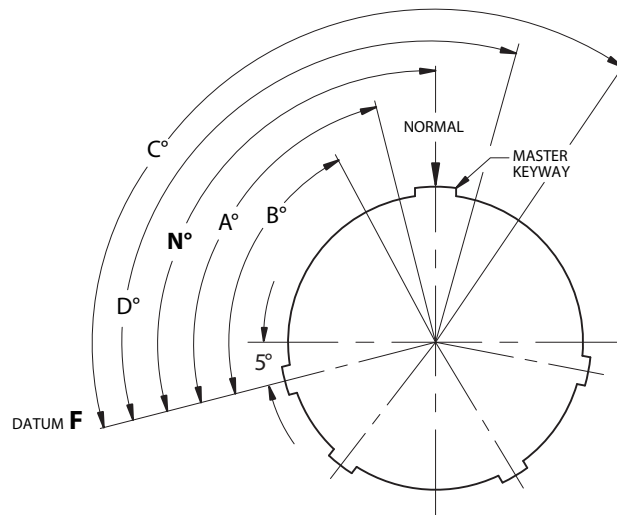

Notes:

1. Mating face of receptacle shown (plug is opposite).
2. The master keyway (key) has various positions relative to DATUM **F**; the minor keyways (keys) remain fixed as shown. In the Normal position, the master keyway (key) is at 95° from DATUM **F**.
3. The angles for a given connector are the same whether it contains pin or socket inserts.
4. The insert arrangement does not rotate relative to master keyway (key).

Shell Size	Keying Positions				
	N°	A°	B°	C°	D°
9	95	77	–	–	113
11	95	81	67	123	109
13	95	75	63	127	115
15	95	74	61	129	116
17	95	77	65	125	113
19	95	77	65	125	113
21	95	77	65	125	113
23	95	80	69	121	110
25	95	80	69	121	110

MIL-DTL-38999 Series I

Flange and Jam Nut Receptacles

Panel Cutouts



MIL-DTL-38999 S I

Panel Cutouts

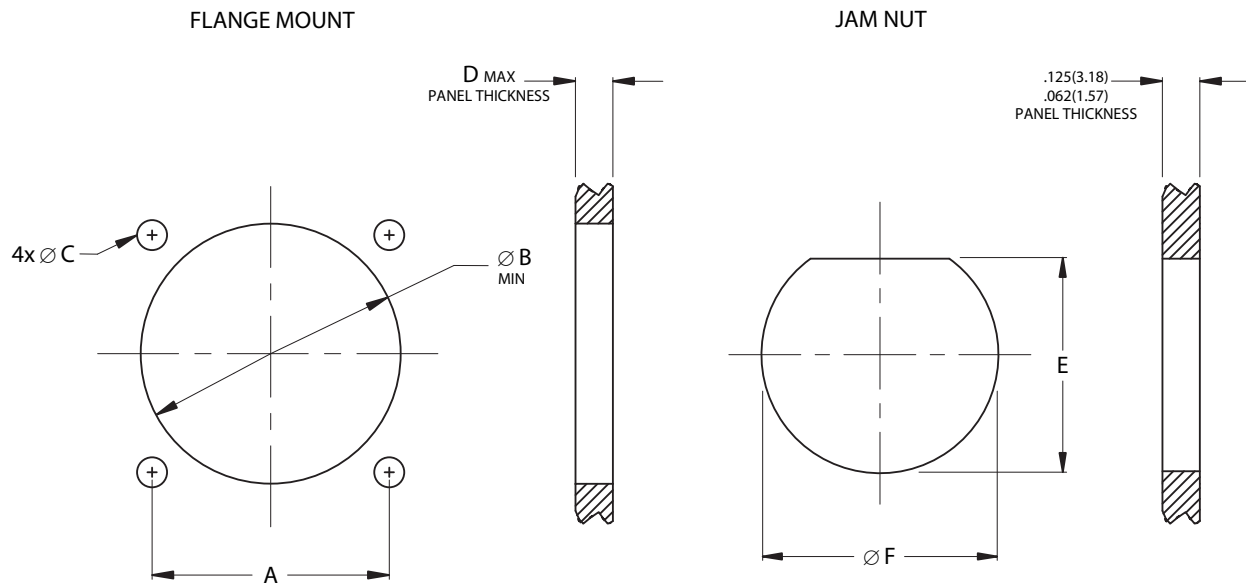

Note 1: Flange Mounting Dimensions (\varnothing B cutout and D MAX) listed only for back of panel mounting (MS27505 and MS27656).

Note 2: D MAX includes mounting hardware.

Flange and Jam Nut Mounting Dimensions

Shell Size	A		\varnothing B		\varnothing C		D		E		\varnothing F	
	(TP)		Minimum		\pm .005	\pm .13	Maximum		+ .000	+ .00	+ .010	+ .25
	inch	mm	inch	mm	inch	mm	inch	mm	- .010	- .25	- .000	- .00
9	.719	18.26	.656	16.66	.128	3.25	.234	5.94	.670	17.02	.700	17.78
11	.812	20.62	.796	20.22	.128	3.25	.234	5.94	.771	19.59	.825	20.96
13	.906	23.01	.922	23.42	.128	3.25	.234	5.94	.955	24.26	1.010	25.65
15	.969	24.61	1.047	26.59	.128	3.25	.234	5.94	1.085	27.56	1.135	28.83
17	1.062	26.97	1.219	30.96	.128	3.25	.234	5.94	1.210	30.73	1.260	32.01
19	1.156	29.36	1.297	32.94	.128	3.25	.234	5.94	1.335	33.91	1.385	35.18
21	1.250	31.75	1.422	36.12	.128	3.25	.204	5.18	1.460	37.08	1.510	38.35
23	1.375	34.93	1.547	39.29	.154	3.91	.204	5.18	1.585	40.26	1.635	41.53
25	1.500	38.10	1.672	42.47	.154	3.91	.193	4.90	1.710	43.43	1.760	44.70



MIL-DTL-38999

Contacts, Tools and Seal Plugs

Series I

Contacts, Plastic Insertion/Removal Tools and Seal Plugs

Contact Size	Application	Pin Contacts	Socket Contacts	Seal Plugs	Insertion/Removal Tools
	Type	Military No.	Military No.	Military No.	Plastic Military No.
22D	Power/Signal	M39029/58-360	M39029/56-348	MS27488-22-1	M81969/14-01
22M*	Power/Signal	M39029/58-361	M39029/56-349		—
22*	Power/Signal	M39029/58-362	M39029/56-350		—
20	Power/Signal	M39029/58-363	M39029/56-351	MS27488-20-1	M81969/14-10
16	Power/Signal	M39029/58-364	M39029/56-352	MS27488-16-1	M81969/14-03
12	Power/Signal	M39029/58-365	M39029/56-353	MS27488-12-1	M81969/14-04
12 Coax	Coax	M39029/28-211	M39029/75-416		
12 Coax	Coax	M39029/102-558	M39029/103-559		
8 Coax	Coax	M39029/60-367	M39029/59-366	MS27488-8-1	M81969/14-06
8 Twinax	Twinax	M39029/90-529	M39029/91-530	MS27488-8-1	M81969/14-12

Crimping and Metal Insertion/Extraction Tools

Contact Size/Type	Crimp Tool	Positioner	Positioner	Insertion Tool	Extraction Tool
	Military No.	For Pin Contacts Military No.	For Socket Contacts Military No.	Metal Military No.	Metal Military No.
22D, 22M*	M22520/2-01	M22520/2-09	M22520/2-07	M81969/8-01	M81969/8-02
22*	M22520/2-01	M22520/2-09	M22520/2-07	M81969/8-03	M81969/8-04
20	M22520/1-01	M22520/1-04	M22520/1-04	M81969/8-05	M81969/8-06
	M22520/2-01	M22520/2-10	M22520/2-10		
16	M22520/1-01	M22520/1-04	M22520/1-04	M81969/8-07	M81969/8-08
12	M22520/1-01	M22520/1-04	M22520/1-04	M81969/8-09	M81969/8-10
12 Coax Inner	M22520/2-01	M22520/2-34	M22520/2-34		
12 Coax Outer	M22520/31-01	M22520/31-02	M22520/31-02		
8 Coax Inner	M22520/2-01	M22520/2-31	M22520/2-31	M81969/8-13**	M81969/8-14
8 Coax Outer	M22520/5-01	M22520/5-05 Die Closure B	M22520/5-05 Die Closure B		
8 Twinax Center	M22520/2-01	M22520/2-37	M22520/2-37	—	—
8 Twinax Outer & Intermediate	M22520/5-01	M22520/5-200	M22520/5-200		

Contact and Wire Data

Contact Size	Test Current	Voltage	Crimp Well Data			Wire Range		Finished Wire \varnothing Range			
	DC Test	Max. Drop	Well Dia.	Minimum Well Dept		AWG	mm ²	Minimum		Maximum	
	Amps	Millivolts	inch	inch	mm			inch	mm	inch	mm
22D	5.0	73	.0345 ±.0010	.141	3.58	28-22	.08-.33	.030	.76	.054	1.37
22M*	3.0	45	.028 ±.001	.141	3.58	28-24	.08-.20	.030	.76	.050	1.27
22*	5.0	73	.0365 ±.0010	.141	3.58	26-22	.13-.33	.034	.86	.060	1.52
20	7.5	55	.047 ±.001	.209	5.31	24-20	.20-.52	.040	1.02	.083	2.11
16	13.0	49	.067 ±.001	.209	5.31	20-16	.52-1.31	.065	1.65	.109	2.77
12	23.0	42	.100 ±.002	.209	5.31	14-12	2.08-3.31	.097	2.46	.142	3.61

* Inactive for new design

** Insertion tool is not required.

Note 1: Test Current and Maximum Voltage Drop when tested with silver-plated wire at 25°C.

Note 2: Size 12 coax contacts purchased in bulk.

Note 3: Size 8 coax contacts are used with M17/095-RG180 cable, while size 8 Twinax contacts are used with M17/176-00002 cable.

MIL-DTL-38999

Contact Installation Instructions

Series I



Contact Installation Instructions

Crimping Contacts

1. Select the appropriate crimp tool and ensure that the proper crimp head positioner is used.
2. Cycle the tool to be sure the indentors are open.
3. Determine the correct selector setting for the wire size from the data plate on the positioner (turret head assembly) and set the selector knob on the crimp tool to match.
4. Place the contact, mating end first, into the tool.
5. Insert the stripped wire into the hollow end of the contact. Be sure the wire is inserted as far as it will go.
6. Close the tool completely to crimp. Unless the tool is closed completely, the tool will not release the contact.
7. Remove the crimped contact from the tool. Check the inspection hole to verify that the wire is fully inserted.

Insertion of Contacts

1. Before inserting the contacts, unscrew the accessories (clamps, backshells or adapters) from rear of plug or receptacle. Slide the hardware over the wire bundle in the proper order for reassembly after all the contacts are inserted.
2. To assist insertion of contacts, lubricate insulator (grommet) cavities with isopropyl alcohol. Alcohol will evaporate and will not leave a conductive film. **Caution: Never use any lubricant other than isopropyl alcohol.**

3. Place the correct insertion tool on the contact so that the wire runs along the groove in the tool. (Tool tip will butt against the shoulder.) Hold the plug or receptacle body firmly.
4. Beginning with a center cavity, insert the contact into the insulator with a slow, even pressure until the contact snaps into position. Make sure the contact and tool are held perpendicular to the face of the insert during the contact installation or the grommet could be damaged.
 - 4.1 If contacts are not inserted all the way prior to removing insertion tool, do not try to reinsert the insertion tool. Instead, remove the contact and try again; otherwise reinserting the insertion tool may damage the inside of the contact cavity.
5. Remove tool and check the face of the connector for proper contact installation. Proper installation may also be checked by pulling back lightly on the wire to make sure the contact is properly seated.

Completion

After all the cavities have been filled, slide the hardware back into position on the connector and tighten.

Extraction of Contacts (Rework)

1. Slide the hardware back over the wire bundle.
2. Select the appropriate tool. Place the wire into the extraction tool of the pin or socket.
3. Slowly slide the extraction tool down wire into the contact cavities until the tool tip bottoms against the contact shoulder, expanding the clip retaining tines. Hold the wire firmly in the tool and pull the wired contact and tool straight out of the rear of the insulator.

Size	Pin Contact	Socket Contact	Basic Crimp Tool	Pin Positioner	Socket Positioner	Insertion/Removal Tool
22D	M39029/58-360	M39029/56-348	M22520/2-01	M22520/2-09	M22520/2-07	M81969/14-01
22M	M39029/58-361	M39029/56-349	M22520/2-01	M22520/2-09	M22520/2-07	M81969/14-01
22	M39029/58-362	M39029/56-350	M22520/2-01	M22520/2-09	M22520/2-07	M81969/14-01
20	M39029/58-363	M39029/56-351	M22520/1-01	M22520/1-04 Red	M22520/1-04 Red	M81969/14-10
			M22520/2-01	M22520/2-10	M22520/2-10	
20	M39029/58-364	M39029/56-352	M22520/1-01	M22520/1-04 Blue	M22520/1-04 Blue	M81969/14-03
12	M39029/58-365	M39029/56-353	M22520/1-01	M22520/1-04 Yellow	M22520/1-04 Yellow	M81969/14-04

For coax and twinax contacts refer to instructions that are supplied with contacts.



MIL-DTL-38999 Series I, II and III Insert Availability and Contact Information per MIL-STD-1560

Insert Availability and Contact Information

Insert Arrangement			Aero-Electric		Service	Total	Quantity of Contacts							
			Status			No. of	(by Size)							
Series I	Series II	Series III	QPL'd	Tooled	Rating	Contacts	22D	22M	22	20	16	12	10	8
9-6*	8-6*	—	Yes	Yes	M	6		6						
9-35	8-35	A35	Yes	Yes	M	6	6							
9-98	8-98	A98	Yes	Yes	I	3				3				
11-2	—	B2	Yes	Yes	I	2					2			
11-4	—	B4	Yes	Yes	I	4				4				
11-5	10-5	B5	Yes	Yes	I	5				5				
11-13*	10-13*	—	Yes	Yes	M	13		13						
11-35	10-35	B35	Yes	Yes	M	13	13							
11-98	10-98	B98	Yes	Yes	I	6				6				
11-99	10-99	B99	Yes	Yes	I	7				7				
—	12-3	—	Yes	Yes	II	3					3			
13-4	12-4	C4	Yes	Yes	I	4					4			
13-8	12-8	C8	Yes	Yes	I	8				8				
13-22*	12-22*	—	Yes	Yes	M	22		22						
13-35	12-35	C35	Yes	Yes	M	22	22							
13-98	12-98	C98	Yes	Yes	I	10				10				
15-5	14-5	D5	Yes	Yes	II	5					5			
15-15	14-15	D15	Yes	Yes	I	15				14	1			
15-18	14-18	D18	Yes	Yes	I	18				18				
15-19	—	D19	Yes	Yes	I	19				19				
15-35	14-35	D35	Yes	Yes	M	37	37							
15-37*	14-37*	—	Yes	Yes	M	37		37						
15-97	14-97	D97	Yes	Yes	I	12				8	4			
17-6	16-6	E6	Yes	Yes	I	6						6		
17-8	16-8	E8	Yes	Yes	II	8					8			
17-26	16-26	E26	Yes	Yes	I	26				26				
17-35	16-35	E35	Yes	Yes	M	55	55							
17-55*	16-55*	—	Yes	Yes	M	55		55						
17-99	16-99	E99	Yes	Yes	I	23				21	2			
19-11	18-11	F11	Yes	Yes	II	11					11			
19-28	18-28	F28	Yes	Yes	I	28				26	2			
19-30	18-30	F30	Yes	Yes	I	30				29	1			
19-32	18-32	F32	Yes	Yes	I	32				32				
19-35	18-35	F35	Yes	Yes	M	66	66							
—	18-53**	—	Yes	Yes	M	53			53					
19-66*	18-66*	—	Yes	Yes	M	66		66						

Please see next page for Shell Sizes 21/20/G thru 25/24/J layouts.

* Not approved for new design. Toolled and qualified but their separate pictorials are not shown on pages 17 thru 19, as they are the same as corresponding (-35) layouts that take same qty of 22D instead of 22M contacts.

** Not approved for new design. Pictorial is shown on page 18.

— above means "not available" for that series.

MIL-DTL-38999 Series I, II and III

Insert Availability and Contact Information

per MIL-STD-1560



Insert Availability and Contact Information (continued)

Insert Arrangement			Aero-Electric		Service	Total	Quantity of Contacts							
			Status			No. of	(by Size)							
Series I	Series II	Series III	QPL'd	Tooled	Rating	Contacts	22D	22M	22	20	16	12	10	8
21-1*	20-1*	—	Yes	Yes	M	79		79						
21-11	—	G11	Yes	Yes	I	11						11		
21-16	20-16	G16	Yes	Yes	II	16					16			
21-35	20-35	G35	Yes	Yes	M	79	79							
21-39	20-39	G39	Yes	Yes	I	39				37	2			
21-41	20-41	G41	Yes	Yes	I	41				41				
21-48**	—	G48**	N/A	Yes	I	4								4 (Power)
21-75	—	G75	Yes	Yes	Twinax	4								4 (Twinax)
23-1*	22-1*	—	Yes	Yes	M	100		100						
23-2***	22-2***	—	Yes	Yes	M	85			85					
23-21	22-21	H21	Yes	Yes	II	21					21			
23-32	22-32	H32	Yes	Yes	I	32					32			
23-35	22-35	H35	Yes	Yes	M	100	100							
23-53	22-53	H53	Yes	Yes	I	53					53			
23-55	22-55	H55	Yes	Yes	I	55					55			
25-1*	24-1*	—	Yes	Yes	M	128		128						
25-4	24-4	J4	Yes	Yes	I	56				48	8			
—	—	J8	Yes	Yes	Twinax	8								8 (Twinax)
—	—	J11	Yes	Yes	N	11				2			9	
25-19	24-19	J19	Yes	Yes	I	19						19		
—	—	J20	Yes	Yes	N, Coax, Twinax	30				10	13	4 (Coax)		3 (Twinax)
25-24	24-24	J24	Yes	Yes	I	24					12	12		
25-29	24-29	J29	Yes	Yes	I	29					29			
25-35	24-35	J35	Yes	Yes	M	128	128							
25-43	—	J43	Yes	Yes	I	43				23	20			
25-46	—	J46****	Yes	Yes	I, Coax	46				40	4			2 (Coax)
25-61	24-61	J61	Yes	Yes	I	61				61				
—	—	J90	Yes	Yes	I, Twinax	46				40	4			2 (Twinax)

* Not approved for new design. Toolled and qualified but their separate pictorials are not shown on pages 17 thru 19, as they are same as corresponding (-35) layouts that take same quantity of 22D instead of 22M contacts.

** 21-48/G48 layout is not to MIL-STD-1560. It is toolled and intended for comm'l use only.

*** Not approved for new design. Pictorial is shown on page 18.

**** J46 in Series III is not QPL'd but can be purchased to comm'l number (Size 8 Coax contact must be used).

— above means "not available" for that series

Note 1: J20P uses 4 size 12 coax contacts as follows: 2 ea M39029/28-211 and 2 ea of M39029/102-558; J20S uses 4 size 12 coax contacts as follows: 2 ea M39029/75-416 and 2 ea of M39029/103-559.

Note 2: Layouts (G75, J8, J20, J46 and J90) that take twinax or coax contacts should not be used for firewall applications (Classes K & S) in Series III.

Note 3: H and J contact styles (in lieu of P & S) are meant for Composite (classes J & M) Series III only. Aluminum (classes A, B, F & W) and Firewall (classes K & S) are rated for 500 cycles regardless what contacts are used.



MIL-STD-1560 Insert Arrangements (Pin Front View) for MIL-DTL-38999 Series I, II and III Connectors

Insert Arrangements Views



9-35/8-35
A35,
6 # 22D, M



9-98/8-98
A98,
3 # 20, I

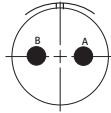

11-2
B2,
2 # 16, I

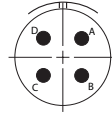

11-4
B4,
4 # 20, I

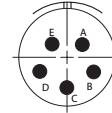

11-5/10-5
B5,
5 # 20, I

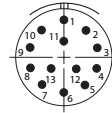

11-35/10-35
B35,
13 # 22D, M

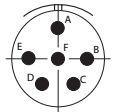

11-98/10-98
B98,
6 # 20, I

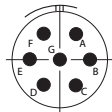

11-99/10-99
B99,
7 # 20, I

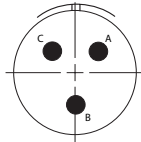

12-3
3 # 16, II

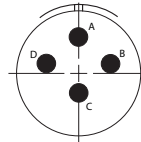

13-4/12-4
C4,
4 # 16, I

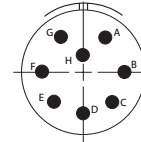

13-8/12-8
C8,
8 # 20, I

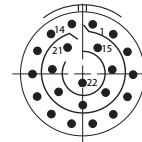

13-35/12-35
C35,
22 # 22D, M

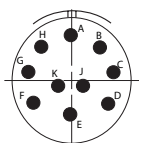

13-98/12-98
C98,
10 # 20, I

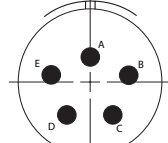

15-5/14-5
D5,
5 # 16, II

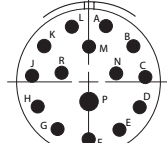

15-15/14-15
D15,
1 # 16, 14 # 20, I

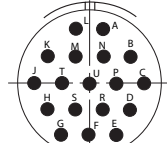

15-18/14-18
D18,
18 # 20, I

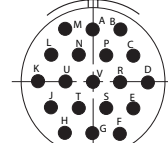

15-19
D19,
19 # 20, I



15-35/14-35
D35,
37 # 22D, M

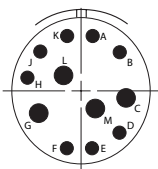

15-97/14-97
D97,
4 # 16, 8 # 20, I

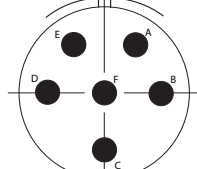

17-6/16-6
E6,
6 # 12, I

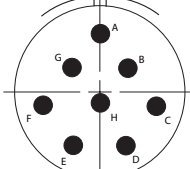

17-8/16-8
E8,
8 # 16, II

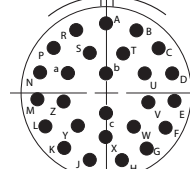

17-26/16-26
E26,
26 # 20, I

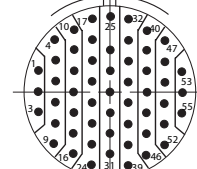

17-35/16-35
E35,
55 # 22D, M

MIL-DTL-38999 S I

38999 S II

38999 S III

MIL-STD-1560 Insert Arrangements (Pin Front View) for MIL-DTL-38999 Series I, II and III Connectors



MIL-DTL-38999 S I
38999 S II
38999 S III

Insert Arrangements Views

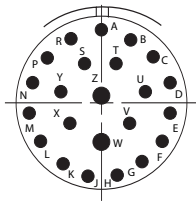

17-99/16-99
E99,
2 # 16, 21 # 20, I

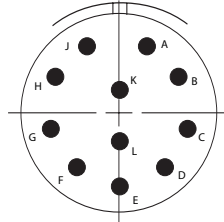

19-11/18-11
F11,
11 # 16, II

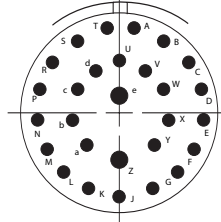

19-28/18-28
F28,
2 # 16, 26 # 20, I

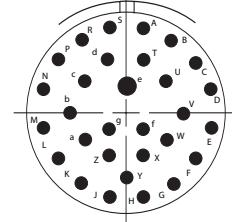

19-30/18-30
F30,
1 # 16, 29 # 20, I

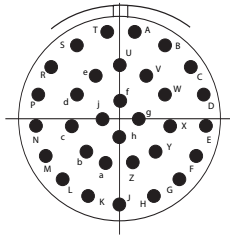

19-32/18-32
F32,
32 # 20, I

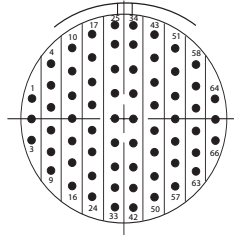

19-35/18-35
F35,
66 # 22D, M

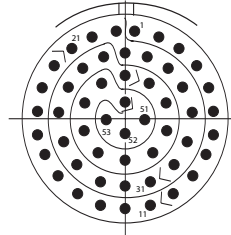

18-53*
53 # 22, M

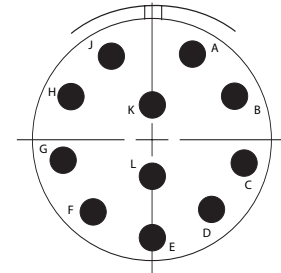

21-11
G11,
11 # 12, I

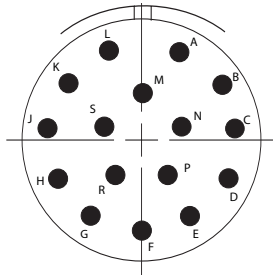

21-16/20-16
G16,
16 # 16, II

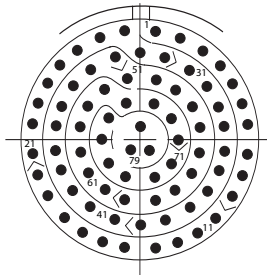

21-35/20-35
G35,
79 # 22D, M

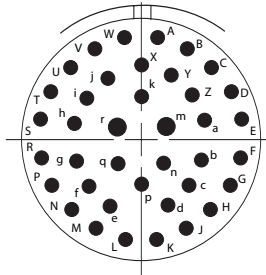

21-39/20-39
G39,
2 # 16, 37 # 20, I

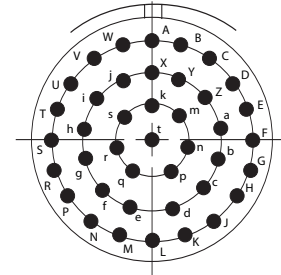

21-41/20-41
G41,
41 # 20, I

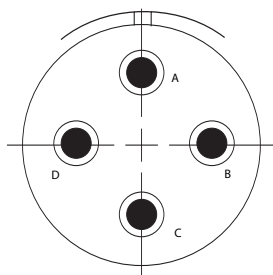

21-48**
G48**,
4 # 8 Power, I

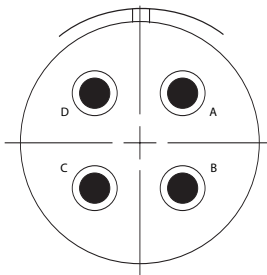

21-75
G75,
4 # 8 Twinax, Twinax

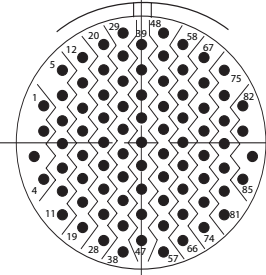

23-2*/22-2*
85 # 22, M

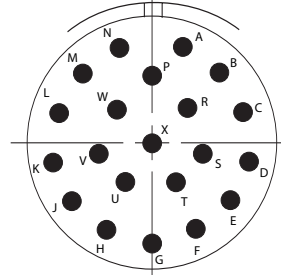

23-21/22-21
H21,
21 # 16, II

* Inactive for new design.
** Not MIL-STD-1560 layout (not QPL'd).



MIL-STD-1560 Insert Arrangements (Pin Front View) for MIL-DTL-38999 Series I, II and III Connectors

Insert Arrangements Views

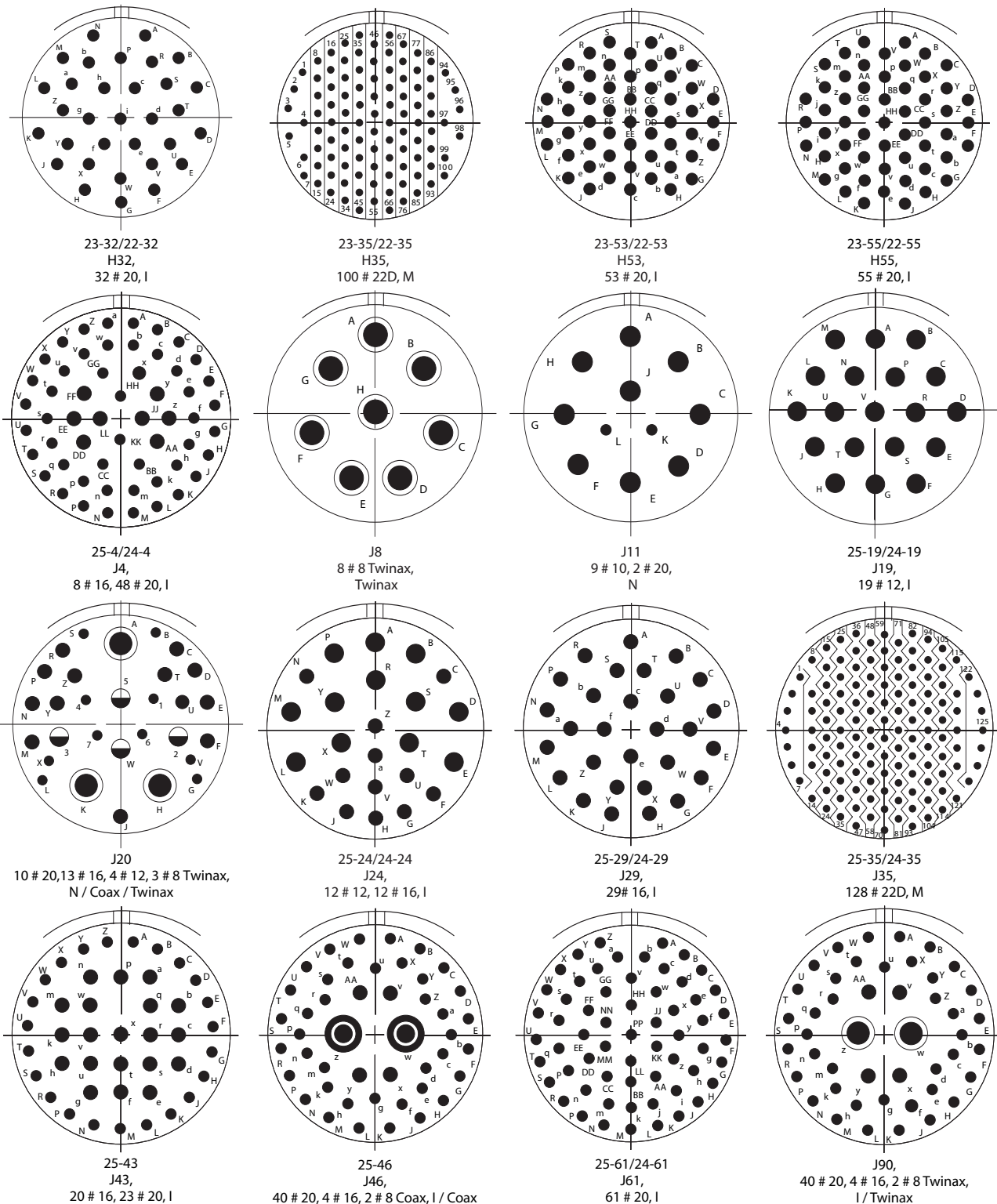

MIL-DTL-38999 S I
38999 S II
38999 S III